

Modern Steel Construction

April 2024



PEDDIASSEMBLER VS MANUAL

TRIPLE PASS WELD 6.6 TONS OF STEEL



THE
PEDDIASSEMBLER

**5 HOURS
59 MINUTES**

- 111 TACKS
- 215 WELDS
- 45 PARTS
- 31 ROTATIONS
- 0 ERRORS



MANUAL FIT & TACK

**13 HOURS
12 MINUTES**

- 256 TACKS
- 216 WELDS
- 45 PARTS
- 35 ROTATIONS

**WATCH
HERE**



Peddinghaus

STRONGER THAN
STEEL®

www.peddinghaus.com | info@peddinghaus.com | (815) 937-3800

It's All About the NUTS AND BOLTS

**Get the industry's best structural bolts and anchor bolts,
available coast to coast.**

Fasteners play a crucial role in the construction of nearly everything. Get yours from a partner equipped to do whatever it takes to meet your deadlines with high-performing products.

- ✓ Largest U.S. distributor and manufacturer of structural bolts and hardware
- ✓ Rush delivery on structural bolts and hardware
- ✓ Expert support throughout the purchasing process
- ✓ Fast turnaround times on anchor bolts
- ✓ Rotation capacity testing
- ✓ Jobsite assistance



Scan the QR code to explore our solutions for the structural steel industry and find the right components to keep jobs moving forward.

Modern Steel Construction

April 2024

46

in every issue

departments

- 6 EDITOR'S NOTE
- 8 STEEL INTERCHANGE
- 10 STEEL QUIZ
- 60 NEW PRODUCTS
- 61 NEWS & EVENTS
- 66 STRUCTURALLY SOUND

resources

- 65 ADVERTISER INDEX
- 65 MARKETPLACE & EMPLOYMENT

features

- 24 Energy Efficient**
BY JEFFREY CHAN, PE, SHAMIL LALLANI,
AND FLORIAN MEIER, PE
Dramatic steel cantilevers and an
innovative façade design help an energy
research laboratory save energy.
- 30 A Bet on Steel**
BY JOE PORADA, SE, PE, KEVIN JACKSON,
SE, PE, AND CHRIS PORST, SE
A new sportsbook adjacent to Wrigley
Field showcases steel's ability to integrate
into an existing structure.
- 38 Rapid Response**
BY BRENDA CRUDELE, PE, JULIANNE FUDA,
PE, AND RONNIE MEDLOCK, PE
The steel industry's emergency repair
skills ensured a replacement for a flood-
damaged upstate New York bridge opened
within mere months.

- 46 Artistic Connections**
BY KAITLYN M. PALMER, SE, PE, NATHAN C.
ROY, PE, KEVIN BERGERON, AIA, AND
MICHAEL PRATTICO, AIA
An innovative fine arts building used steel
to achieve its desired open layout and
undulating glass façade, helping make it a
campus centerpiece.
- 54 Architect's Angle**
INTERVIEW BY PATRICK ENGEL
An architect shares his perspective on
designing with the SpeedCore structural
system.

columns

steelwise

- 14 Doubling Up on HSS**
BY JEFFREY A. PACKER, PENG, PHD
AISC's second edition of Design Guide 24
more than doubles the resources for hollow
structural section connection design.

field notes

- 19 Veteran Voice**
INTERVIEW BY GEOFF WEISENBERGER
Prominent fabrication engineer Mark
Holland's first employer is so far his only
one—after four decades.

business issues

- 22 Deciding on Delegated Design**
BY EDWARD SEGLIAS
Delegated design can work for many
steel projects, but understanding the risks
beforehand is crucial.

ON THE COVER: Steel delivered a University of Pennsylvania laboratory's desired cantilevering form and façade, p. 24. (Photo: knippershelbig)

MODERN STEEL CONSTRUCTION (Volume 64, Number 4) ISSN (print) 0026-8445; ISSN (online) 1945-0737. Published monthly by the American Institute of Steel Construction (AISC), 130 E Randolph Street, Suite 2000, Chicago, IL 60601. Single issues \$8.00; 1 year, \$60. Periodicals postage paid at Chicago, IL and at additional mailing offices. Postmaster: Please send address changes to MODERN STEEL CONSTRUCTION, 130 E Randolph Street, Suite 2000, Chicago, IL 60601.

DISCLAIMER: AISC does not approve, disapprove, or guarantee the validity or accuracy of any data, claim, or opinion appearing under a byline or obtained or quoted from an acknowledged source. Opinions are those of the writers and AISC is not responsible for any statement made or opinions expressed in MODERN STEEL CONSTRUCTION. All rights reserved. Materials may not be reproduced without written permission, except for noncommercial educational purposes where fewer than 25 photocopies are being reproduced. The AISC and Modern Steel logos are registered trademarks of AISC.



Printed on paper made
from a minimum of
10% recycled content.



AT 70 FEET, FACE-TO-FACE WITH
5,000 POUNDS OF STEEL,
YOU NEED A PARTNER WHO
**HAS YOUR
BACK.**

Using JLG equipment is not just about lift — it's about trust. Trust in equipment that remains steadfast and unflinching in tough conditions. Trust in a partner that puts your safety and success above all. Every day, JLG takes pride in delivering on that trust, allowing you to remain confident that the mark you leave today will build a stronger tomorrow.

LEAVEYOURMARKWITHJLG.COM

JLG[®]



“Hello!” was the oft-repeated cheerful singsong greeting of a majestic scarlet macaw named Geoff at the main entrance to the Wyndham Grand Rio Mar Puerto Rico, about an hour east of San Juan, where we spent a brief mid-winter getaway in January.

His counterpart, Bob, an equally striking macaw, sat just across the main stairway leading into the hotel. While not as verbose as Geoff, Bob attracted just as much attention from guests making their way up and down the stairs. But for some reason, I just didn't have as much of a connection with him as I did with Geoff. I can't quite put my finger on it...

Speaking of fingers, both birds had signs next to their spacious cages reminding guests not to touch the feathered greeters. Signs like this are typically posted as the result of daring souls who insist on learning lessons the hard way (a scarlet macaw can apparently produce 330 psi of pressure with its bite, enough to crack a Brazil nut and also the finger bones of a rum-drunk tourist).

I like my fingers, so it wasn't a big ask to keep them to myself and away from any curious beaks. However, on one excursion away from the hotel, our group ignored the warning signs. In the interest of brevity, let's just say that we hiked a rainforest trail that wasn't exactly open at the time. We knew the risks, we did it anyway, we were careful, we made it out with no injuries (aside from the pride of someone who slipped in the mud and was ridiculed for the remainder of the hike; don't worry, she laughed it off), and all was well. Should we have done it? Probably not. Was it worth it? Absolutely. I love *The Lord of the Rings* trilogy and its precursor, *The Hobbit*, and equated our brief adventure with leaving the Old Forest Road in Mirkwood (but without the giant spiders, thank goodness).

All this is to say that safety matters—especially in the world of steel construction—and the signs are there for a reason. When people follow the rules and don't rely on luck

(and good hiking shoes) to keep them safe, things generally go well.

And it's not just about signs; it's about creating a culture of safety that all participants—in a company, organization, or even an entire industry—buy into. Want an example? How about dozens and dozens? Check out the long list of winners of AISC's 2023 Safety Awards starting on page 61 in our News section. More than 180 AISC member fabricators and erectors were recognized for their outstanding safety records, and approximately three-fourths of them received the Safety Award of Honor, which is presented for a perfect record of no disabling injuries. It's a noteworthy achievement in an industry that relies on plasma cutters, bandsaws, overhead cranes, welding torches, press brakes, shot blasters, massive drills, and other heavy equipment that's strong enough to cut, shape, and assemble steel members.

If you're looking for specifics on how to make your shop, jobsite, or even office a safer environment, you can sign up for AISC's Steel Academy (found at aisc.org/learning), which includes a safety program among its groups of multi-session, self-paced courses. And be sure to check out the Steel Quiz on page 10, which focuses on current safety practices and OSHA regulations.

Meanwhile, stay safe, keep your fingers away the macaws, and heed the words of Gandalf the Grey—"Do not stray off the track!"—and avoid any ill-advised hikes!

Geoff Weisenberger
Geoff Weisenberger
Editor and Publisher

Modern Steel Construction

Editorial Offices

130 E Randolph St, Ste 2000
Chicago, IL 60601
312.670.2400

Editorial Contacts

EDITOR AND PUBLISHER
Geoff Weisenberger
312.493.7694
weisenberger@aisc.org

ASSOCIATE EDITOR

Patrick Engel
312.550.9652
engel@aisc.org

SENIOR DIRECTOR OF PUBLICATIONS

Keith A. Grubb, SE, PE
312.804.0813
grubb@aisc.org

GRAPHIC DESIGN MANAGER

Kristin Hall
773.636.8543
hall@aisc.org

EDITORIAL DIRECTOR

Scott Melnick
312.804.1535
melnick@aisc.org

AISC Officers

CHAIR

Hugh J. McCaffrey
Southern New Jersey Steel Co.

VICE CHAIR

Glenn R. Tabolt, PE
STS Steel, Inc.

SECRETARY/LEGAL COUNSEL

Edward Seglias, Cohen Seglias
Pallas Greenhall & Furman, PC

PRESIDENT

Charles J. Carter, SE, PE, PhD

SENIOR VICE PRESIDENTS

Scott Melnick
Mark W. Trimble, PE

VICE PRESIDENTS

Todd Alwood
Carly Hurd
Mike Mospan
Christopher H. Raebel, SE, PE, PhD
Brian Raff

Editorial Advisory Panel

Brandon Chavel, PE, PhD
Michael Baker International

Nat Killpatrick
Basden Steel

Christina McCoy, SE
Oklahoma State University
School of Architecture

Allison Shenberger, PE
ruby+associates

Justin Smith, PE
Dekker Perich Sabatini

Advertising Sales

Geoff Weisenberger
312.493.7694
weisenberger@aisc.org

Address Changes and Subscription Concerns

312.670.2401
subscriptions@aisc.org

Reprints

Kristin Hall
hall@aisc.org



SDS2
BY ALLPLAN

The details are automatic.

When it comes to steel detailing, automating the little things makes a big difference. Trust SDS2 to handle some of your most repetitive and time-consuming detailing tasks to save you time, improve your accuracy, and let you focus on more important things. Like winning bigger projects, perfecting your workflows—and taking vacation.

AUTOMATE MORE

- Structural modeling
- Stairs and rails
- Connections
- Detailing and shop drawings
- Piecemarking
- Clash detection
- Material takeoffs
- CNC exports
- Revisions

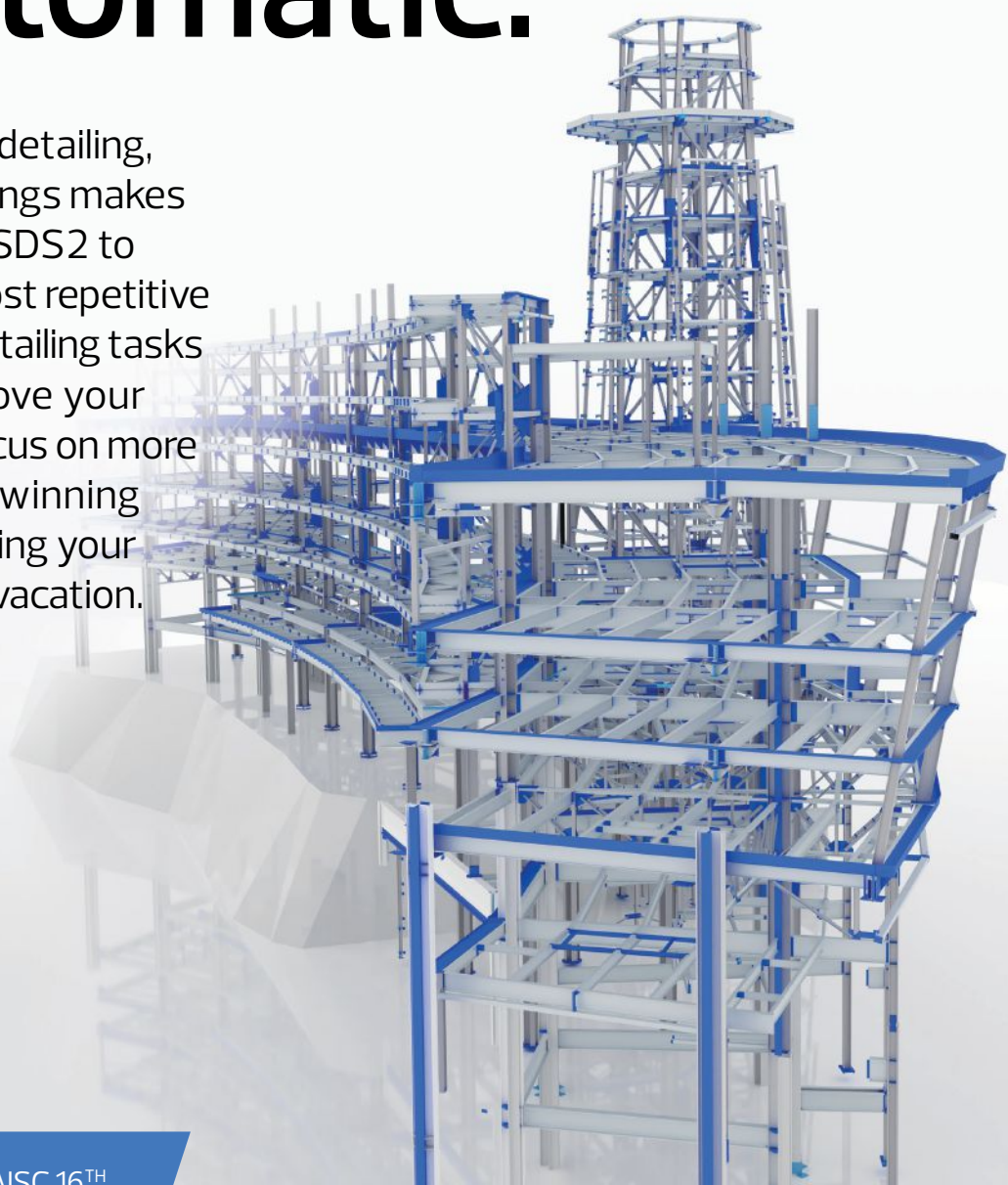

SDS2 2024 available now with AISC 16TH
& CISC 12TH edition updates

Model by Mold-Tek Technologies \ Gillette Stadium North End zone Renovation

sds2.com

SEE IT FOR YOURSELF
REQUEST A DEMO TODAY



steel interchange

If you've ever asked yourself "Why?" about something related to structural steel design or construction, *Modern Steel's* monthly Steel Interchange is for you!

Send your questions or comments to solutions@aisc.org.

Is Weld Reinforcement Required per AISC 341?

I am working on a project that needs to meet the requirements of AISC *Seismic Provisions for Structural Steel Buildings* (ANSI/AISC 341-22). I believe all groove welds that connect members to column flanges (tee or corner type joints) are required to be reinforced. Is this correct?

This is not correct.

Section A4.2 of the 2016 *Seismic Provisions* states, "In addition to the requirements of Section A4.1, structural design drawings and specifications for steel construction shall indicate the following items, as applicable... (i) Locations where fillet welds are required to reinforce groove welds or to improve connection geometry."

The Commentary states, "In tee and corner joints where loads are perpendicular to the weld axis, a reinforcing fillet weld applied to a CJP groove weld reduces the stress concentration at the corner between the weld face or root and the member. AWS D1.8/D1.8M provides details for reinforcing fillet welds. Such reinforcement is not required for most groove welds in tee or corner joints."

The Commentary to the 2022 *Seismic Provisions* states, "Section A4.2(i) as contained in the 2016 *Provisions* is removed from the 2022 edition. In the years that immediately followed the 1994 Northridge earthquake, there was some thought that reinforcing fillet welds may be needed for some connections to reduce through-thickness loading on column flanges; Dexter and Melendrez (1999) showed that such fillet welds were not necessary."

"None of the prequalified moment connections listed in AISC *Prequalified Connections for Special and Intermediate Steel Frames for Seismic Applications*, (ANSI/AISC 358-22), require reinforcing fillet welds, and these provisions do not mandate such fillets. Accordingly, this section has been deleted. The deletion of this item does not preclude the engineer of record from specifying such fillet welds if needed for a specific design."

As indicated in the commentary, there was a time when it was "thought that reinforcing fillet welds may be needed for some connections to reduce through-thickness loading on column flanges," but this was resolved in the late 1990s. While not prohibited, "...reinforcement is not required for most groove welds in tee or corner joints."

Larry Muir, PE

Rolled Heavy Shapes

Section A3.1d in the AISC *Specification for Structural Steel Buildings* (ANSI/AISC 360-22) has Charpy V-notch (CVN) requirements (ASTM A6/A6M, Supplementary Requirement S30) for rolled heavy shapes used as members subjected to primary (computed) tensile forces due to tension or flexure and splice or connected using complete-joint penetration groove welds that fuse through the thickness of the flange or the flange. Is the fabricator responsible for ordering material with the Supplementary Requirement S30 if the structural design documents do not indicate the shapes that need to meet these requirements?

No. The 2022 AISC *Specification* states in Section A3.1d, "...The structural design documents shall require that such shapes be supplied with Charpy V-notch (CVN) impact test results in accordance with ASTM A6/A6M, Supplementary Requirement S30, Charpy V-Notch Impact Test for Structural Shapes—Alternate Core Location." Section A3.1e has a similar statement.

Then Section A4.1 provides a list of "information, as applicable, to define the scope of the work to be fabricated and erected," which includes item "(u) Charpy V-notch toughness (CVN) requirements for rolled heavy shapes or built-up heavy shapes, if different than what is required in Section A3."

If you must comply with the *Specification*, then you must comply with requirement A3.1d and/or e which says that the "structural design documents shall require...". Section A4.1 states that you include "CVN requirements...if different than what is required in Section A3". If a shape needs CVN requirements it must be indicated in the structural design documents.

However, if the specification of the particular CVN requirements is different than what is described in A3 (say you want a different average value of absorbed energy or maximum temperature, for example), then that must be specified. Section A4.1 (u), which focuses on specifying CVN requirements when different from the requirements in Section A3.1d, does not eliminate the need to specify the shapes that require S30 per Section A3.1d in the structural design documents.

This is consistent with a December 2015 Steel Interchange question (found at [aisc.org/cvninterchange](https://www.aisc.org/cvninterchange)) that discusses CVN requirements in the 2010 AISC *Specification* and responsibility for

All mentioned AISC publications, unless noted otherwise, refer to the current version and are available at [aisc.org/publications](https://www.aisc.org/publications). *Modern Steel* articles can be found at www.modernsteel.com.

specifying CVN when required. While the interchange linked below is based on older versions of the *Specification* and *Code of Standard Practice for Steel Buildings and Bridges* (ANSI/AISC 303-22), the intent relative to these requirements has not changed.

Part 2 of the *16th Edition Steel Construction Manual* also points to the information in the *2022 Specification*. Page 2–28 has a list of required information in the construction and contract documents, which includes item (u) from *Specification* Section A4.1. Page 2–30 has a list of information required only when specified. It states, “The following provisions are invoked only when specified in the contract documents: 1. Material notch-toughness requirements, per *Specification* Section A3.1d and Section A3.1e, see item 1.u in Required Information from *Specification* Section A4.1 provided previously.”

This indicates that the provisions in A3.1d and A3.1e are invoked only when specified in the contract documents.

If CVN requirements were not specified but should have been, *Code* Section 1.6.1 states, “When the ODRD provides the design, design documents, and specifications, the fabricator and the erector are not responsible for the suitability, adequacy, or building-code conformance of the design.” Section 1.6.2 has different requirements when the owner enters into a direct contract with the fabricator to design and fabricate an entire, completed steel structure.

Section 3.1 of the *Code* discusses structural design documents and specifications issued for construction and states, “Structural design documents and specifications issued for construction for all or a portion of the work shall be based upon a completed design for the scope of work represented and provide the following information, as applicable, to define the work to be fabricated and erected: ... (b) Information as required in *Specification* Section A4 and ANSI/AISC 341 Section A4.”

The Commentary to this section states, “The engineer of record should also consider all or a portion of the specified information to be shown on structural design documents and specifications used for ordering structural steel or placing mill orders. Changes made after ordering structural steel or placing mill orders will likely lead to change orders if not properly coordinated and addressed in a timely manner prior to construction. Revisions to the design documents and specifications are covered under Section 3.6.”

Yasmin Chaudhry, PE

Hooked Anchor Rods in Tension

In the 16th edition *Manual*, page 14–10 addressed hooked anchor rods and states, “Hooked anchor rods, as illustrated in Figure 14-6(a), should be used only for axially loaded members subject to compression only to locate and prevent the displacement or overturning of columns due to erection loads or accidental collisions during erection.”

However, the concrete and masonry codes have calculations for hooked anchor rods in tension. Have I correctly interpreted the intent of the *Manual* that hooked anchor rods subject to tension are not recommended?

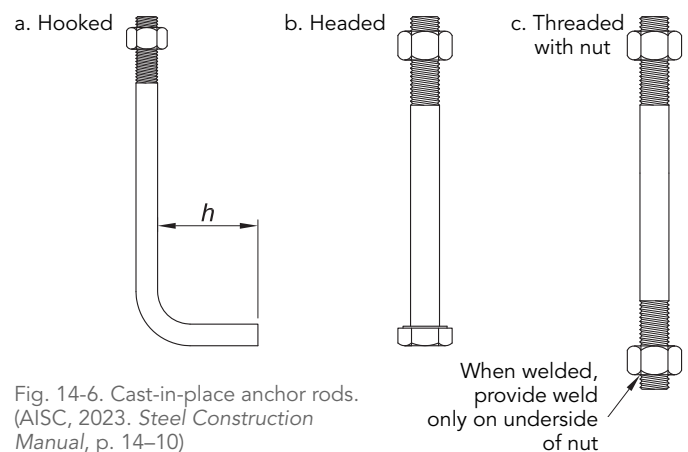

Fig. 14-6. Cast-in-place anchor rods. (AISC, 2023. *Steel Construction Manual*, p. 14–10)

Yes. There is no prohibition against using hooked anchor rods to resist tension, though there is a great deal of discouragement against this practice.

AISC Design Guide 1: *Base Plate and Anchor Rod Design* (found at aisc.org/dg) states, “Hooked anchor rods can fail by straightening and pulling out of the concrete. This failure is precipitated by a localized bearing failure of the concrete above the hook. A hook is generally not capable of developing the required tensile strength. Therefore, hooks should only be used when tension in the anchor rod is small.”

It is true that the concrete and masonry codes have calculations for hooked anchor rods in tension—as recognized in Design Guide 1, which addresses relatively common practices while simultaneously indicating that these practices are best avoided or approached with caution.

Larry Muir, PE

Steel Interchange is a forum to exchange useful and practical professional ideas and information on all phases of steel building and bridge construction. Contact Steel Interchange with questions or responses via AISC’s Steel Solutions Center: 866.ASK.AISC | solutions@aisc.org. The complete collection of Steel Interchange questions and answers is available online at www.modernsteel.com.

The opinions expressed in Steel Interchange do not necessarily represent an official position of the American Institute of Steel Construction and have not been reviewed. It is recognized that the design of structures is within the scope and expertise of a competent licensed structural engineer, architect or other licensed professional for the application of principles to a particular structure.

Yasmin Chaudhry (chaudhry@aisc.org) is a senior engineer in AISC’s Steel Solutions Center. Larry Muir is a consultant to AISC.



STEEL SOLUTIONS CENTER

steel quiz

Safety is crucial on any project. This month's quiz tests your knowledge of current safety practices and Occupational Safety and Health Administration (OSHA) regulations in the fabricated and erected structural steel industry.

- Per OSHA safety regulations, in which of the following details (below) are the headed studs permitted to be shop attached?
 - Part 1
 - Part 2
 - Part 14
 - None of the above
- Which part of the 16th Edition Steel Construction Manual includes information on OSHA requirements for erection safety?
 - Part 1
 - Part 2
 - Part 14
 - None of the above
- True or False:** A base plate for a post that weighs less than 300 lb must be designed and fabricated with a minimum of four anchor rods.
- True or False:** A minimum of two bolts per connection, or their equivalent, is required to connect solid-web members (beams).
- What is the minimum column splice height above the finished floor at perimeter columns?
 - 36 in.
 - 40 in.
 - 48 in.
 - 50 in.
- True or False:** All joists less than 40 ft long must be field-bolted to their supports.

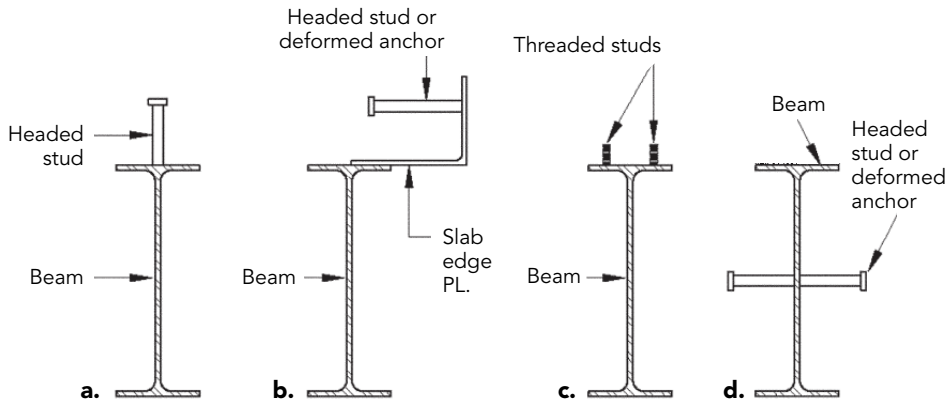

TURN TO PAGE 14 FOR ANSWERS



voortman FABRICATOR

AUTOMATED FITTING AND FULL-WELDING FOR THE STEEL FABRICATING INDUSTRY

The Fabricator is the premier welding system for structural steel, whose flexibility lets you choose on-the-fly between Fit & Weld or only Fit. We offer the quickest turnarounds, maximum efficiency in space utilization and choice-based flexibility – that's what makes our ROI the fastest on the market.

- Ensure on-schedule project with reliable and flexible welding capacity;
- Access a flexible workhorse free from staffing constraints;
- Achieve consistent, high-quality welds, beat material tolerances;
- Secure the quickest return on investment in the market.

READ MORE ABOUT THE FABRICATOR



voortman

Voortman USA LLC / 26200 S. Whiting Way / Monee, IL 60449 - USA / +1 708 885 4900 WWW.VOORTMANCORP.COM

Discover



ShapeBuilder

“How stiff is that crane girder?”

The screenshot shows the ShapeBuilder software interface. The main window displays a 3D model of a crane girder. A table of geometric properties is overlaid on the right side of the window.

Geometric Properties	
Area	104.3 in ²
Ix	15838.7 in ⁴
Ixy	0.0 in ⁴
Iy	1696.6 in ⁴
Sx+	911.4 in ³
Sx-	1005.9 in ³
Sy+	181.0 in ³
Sy-	181.0 in ³
Xc	0.0 in
Yc	1.7 in
rx	12.3 in
ry	4.0 in

Meet Your Next Section Properties Calculator

Investigate custom members, extrusions, built-up parts, copes, holes, stress distribution, shear and torsion, plastic modulus, paint perimeter, shear flow, doubled and tripled shapes, flitch beams, composites, architectural sections, warping normal, corrosion, forensic shapes
all materials...



easy.iesweb.com

Watch the video, **get your free trial**, and get answers in just 10 minutes.

steel quiz : ANSWERS

Answers and more information can be found in the *Manual, Detailing for Steel Construction*, 3rd edition, or the *OSHA Safety and Health Standards for the Construction Industry, 29 CFR 1926 Subpart R Safety Standards for Steel Erection*.

- 1 **d.** OSHA Section 1926.754(c) (1) states, "Shear connectors (such as headed steel studs, steel bars or steel lugs), reinforcing bars, deformed anchors or threaded studs shall not be attached to the top flanges of beams, joists or beam attachments so that they project vertically from or horizontally across the top flange of the member until after the metal decking, or other walking/working surface, has been installed." The studs in (a), (b), and (c) are not permitted because they obstruct the walking surface.
- 2 **b.** Part 2 of the *Manual* has a summary of selected OSHA requirements and related recommendations for erection safety. The full regulations text is available at www.osha.gov.

- 3 **False.** Posts (which OSHA defines as weighing less than 300 lb) are distinguished from columns and excluded from the four-anchor-rod requirement for column base plates. OSHA Section 1926.751 defines a column versus a post, and the requirements for column anchorage for erection stability are in OSHA Section 1926.755(a). More information is in a Standard Interpretation at aisc.org/safety.
- 4 **True.** OSHA Section 1926.756(a) (1) states, "During the final placing of solid web structural members, the load shall not be released from the hoisting line until the members are secured with at least two bolts per connection, of the same size and strength as shown in the erection drawings, drawn up wrench-tight or the equivalent as specified by the project structural engineer of record, except as specified in paragraph (b) of this section." Section (b) refers to the minimum bolts

required for erection of diagonal bracing members.

- 5 **c.** OSHA Section 1926.756(e) requires that perimeter columns extend at least 48 in. above the finished floor (constructability permitting) to allow installation of perimeter safety cables. Provision of some method of attaching the top and middle lines of perimeter safety cables is required, and field welding of attachments is not permitted. While this will be subject to normal business arrangements between the fabricator and erector, the fabricator often drills or punches holes for these cables.
- 6 **False.** OSHA Section 1926.757(a)(8) (i) states, "Except for steel joists pre-assembled into panels, connections of individual steel joists to steel structures in bays of 40 ft or more shall be fabricated to allow for field bolting."



COMBiLiFT
LiFTING INNOVATION

UNLOCK EVERY INCH OF YOUR STORAGE SPACE!

ENHANCE THE SAFETY, STORAGE & EFFICIENCY OF YOUR LOGISTICS WITH COMBILIFT

For 25 years, Combilift has been revolutionizing the way steel companies handle and store goods. Our pioneering product range of multidirectional, articulated and pedestrian forklifts, straddle carriers, mobile gantries and container loaders allows you to manoeuvre long loads safely, reduce aisle widths and increase the amount of space available for storage.

CONTACT US TODAY TO FIND OUT HOW COMBILIFT CAN HELP YOU UNLOCK EVERY INCH OF YOUR STORAGE SPACE.

combilift.com



Basic Steel Design

Presented by Louis F. Geschwindner, PE, PhD

Tuesday nights | 7:00 p.m. Eastern Time

Eight sessions presented as 90-minute webinars.

Course includes access to recordings.

- 4/9 Introduction to Basic Steel Design
- 4/16 Design of Tension Members
- 4/23 Design of Compression Members
- 4/30 Design of Beams
- 5/7 Compression Plus Bending
- 5/14 Stability Analysis and Design, Part I
- 5/21 Stability Analysis and Design, Part II
- 5/28 Design of Composite Flexural Members

Class begins April 9th!



aisc.org/nightschool



Smarter.
Stronger.
Steel.

Doubling Up on HSS

BY JEFFREY A. PACKER, PENG, PHD

AISC’s second edition of Design Guide 24 more than doubles the resources for hollow structural section connection design.

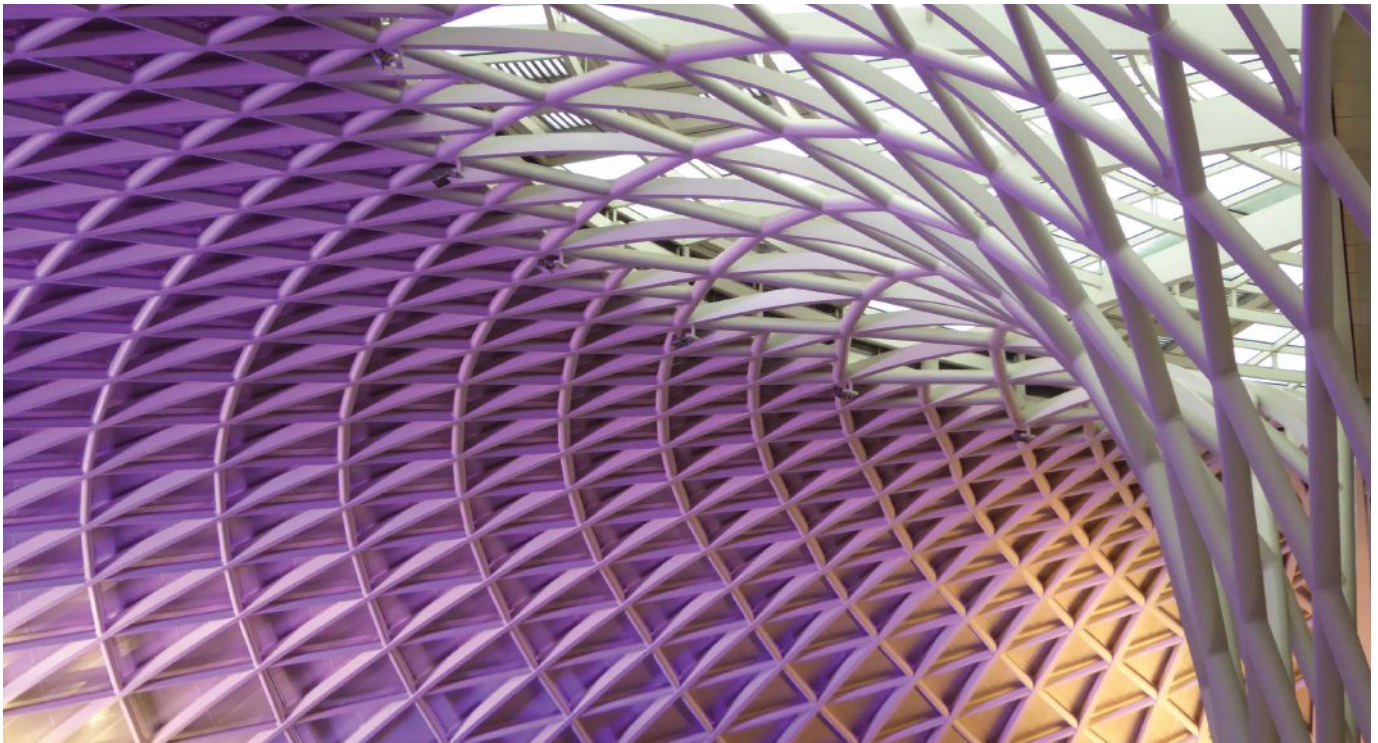

HOLLOW STRUCTURAL SECTIONS (HSS) are a designer’s dream because they check a lot of boxes: good properties in both geometric axes, torsionally stiff, lightweight, lower surface area relative to counterpart open sections, and environmentally astute (less steel in most applications). HSS is aesthetically appealing and ideal for free-form architectural design (Figure 1). They are optimal for columns, bracings, trusses, and large-span roofs, especially when members are to be exposed.

They have one drawback, though. Connections—and for two main reasons: how can a designer bolt to an HSS member when nuts can’t be put on the inside, and how can a designer join to a flexible connecting surface (Figure 2) that doesn’t have a stiffener (or web) behind it?

These questions are thoroughly addressed in AISC’s new Design Guide 24: *Hollow Structural Section Connections*, Second Edition. The required design skill and fabrication art can be gained by referencing this modern manual for HSS in steel construction, found at aisc.org/dg.

How does the second edition of Design Guide 24 compare to its predecessor? First, it’s more than twice the size. It contains more explanation and guidance, covers more connection types, and has many more design examples. It’s up to date with the current AISC *Specification for Structural Steel Buildings* (AISC 360-22) and the *16th Edition Steel Construction Manual*. Like the first edition, the scope of the new design guide pertains to predominantly static loading. The gaps between *Specification* Chapters J and K and the *Manual*—and their application to HSS connections—are filled.

Fig. 1. Roof structure of a 21st century railway station, using round HSS.

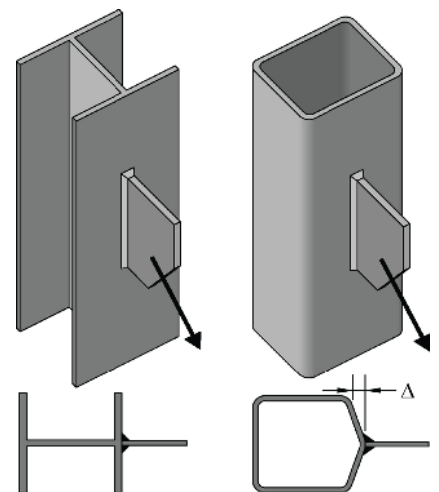

Fig. 2. Effect of out-of-plane loading on the flange element for wide-flange versus rectangular HSS members.

Contents by Chapter

Chapter 1 – Introduction starts with inspiring applications, illustrates current HSS manufacturing methods, and reviews the important features of tubular product standards (ASTM A500, A1085, A1065, A847, A53, A501, A618, A1110, A1112; API 5L; CSA G40). The advantages of HSS are pointed out with regard to: AESS, torsion, compression, surface area, concrete filling, resistance to fluid flow, cold and hot bending, and connecting to castings. Some issues that arise with HSS, such as galvanizing and metalizing, notch toughness, internal corrosion and freezing, and fire protection, are discussed.

The essential principles of HSS connection design are pointed out in this early stage. To avoid reinforcing connections, which is costly and even disallowed architecturally in many cases, connection design and fabrication criteria must be integrated with structural modeling and member selection. To maximize the strength and stiffness of HSS connections, the through member—the chord in a truss-type connection or the column in a beam-to-column

or bracing-to-column connection—should be relatively thick. Conversely, the branch member in an HSS-to-HSS welded connection should be relatively thin and wide but, for fabrication purposes, still can sit on the “flat” of the chord member if using rectangular HSS.

Chapter 2 – Limit States for HSS Connections, the focus and emphasis of this design guide, is a new chapter where the link between each connection failure mode and its limit state design formula is made. The 10 potential failure modes are covered in detail: chord wall plastification, chord shear yielding (punching shear), branch local yielding due to uneven load distribution, local yielding of chord side walls, local crippling of chord side walls, buckling of chord side walls, shearing of chord cross section, local buckling of chord connecting face, shear yielding of overlapped branches, and chord distortional failure. The chapter also has an explanation of how connection ultimate strength is determined. Some of these failure modes are illustrated in Figure 3.

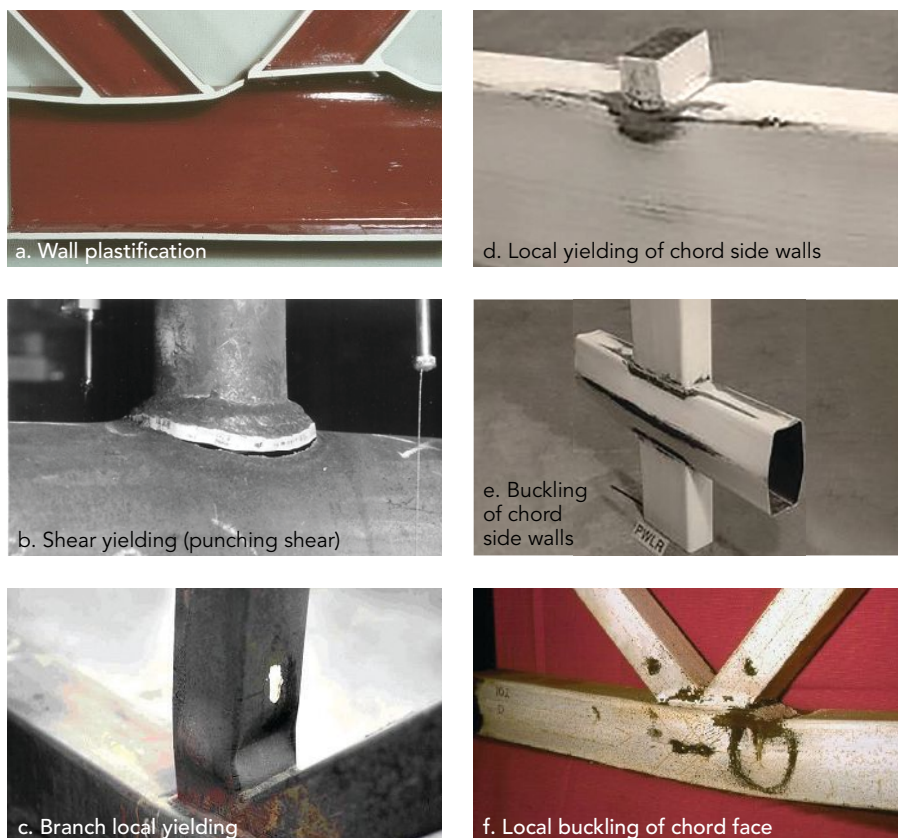
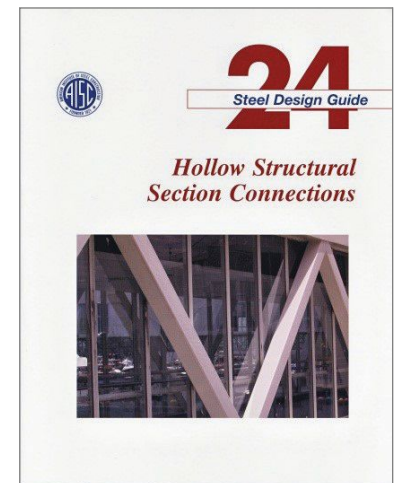

Fig. 3. Examples of HSS connection failure modes (limit states).

Overview of the first and second editions of Design Guide No. 24



1st Edition, 2010
by Jeffrey Packer, Don Sherman & Maura Lecce

- Conformed with AISC 360-05 and 13th edition *Manual* (2005)
- 9 Chapters
- 146 pages
- 21 Design Examples



2nd Edition, 2023
by Jeffrey Packer & Kim Olson

- Conforms with AISC 360-22 and 16th edition *Manual* (2023)
- 10 Chapters
- 344 pages
- 33 Design Examples

Chapter 3 – Welding delves into the aspects of welded fabrication that are especially important for HSS construction. Two weld design philosophies are proffered: design for actual forces in members, in conjunction with weld effective lengths (described in detail); or design to develop the yield capacity of the attached branch wall.

Fillet welds are inherently single-sided to a branch member wall, so when that wall pertains to a rectangular HSS and it is loaded in tension, the directional-strength-increase factor (k_{ds}) cannot be used. That’s because the tension force tends to open the weld joint at the root, as shown in Figure 4a. PJP flare-bevel and flare-V groove welds commonly occur when welding in HSS corner regions (Figure 4b).

The importance of HSS end profiling and beveling is stressed, along with the correct sequence of member overlapping or layup where at least one branch attaches fully to a “through member” (Figure 4c). The chapter concludes with five weld design examples: skewed fillet weld; fillet weld size in a shear connection; transverse weld to a rectangular HSS; welds to a rectangular HSS overlapped K-connection using effective lengths; and welds to a rectangular HSS overlapped K-connection to develop branch capacity.

Chapter 4 – Mechanical Fasteners and Bolted Joints deals with methods for fastening to an HSS closed section. Most limit states for bolted HSS connections are common to all bolted connections, but

some differences (to the classic T-stub model) occur for prying action and some additional HSS limit states need to be considered (HSS wall plastification, and fastener pull-out in tension). The fastening methods covered include through bolts, blind bolts (Figure 5), threaded studs, powder-actuated fasteners and screws. All of them avoid the need for placement of a nut inside the hollow section and structural nut holders. Chapter 4 design examples cover: through-bolt connection in shear; threaded stud-to-HSS connection in tension; and bolted WT-to-HSS connection in tension.

Chapter 5 – Shear Connections covers beam-to-column connections where the joint between the members is not required to transfer moment and will allow for rotation associated with the member behavior under its applied loads. Seven wide-flange beam-to-HSS column connection types are described from least expensive to most expensive, starting with the popular single-plate (also known as shear tab) connection shown in Figure 6 (for which there is a design example). The other six are single-angle connection; double-angle connection (with a design example); WT connection; unstiffened seat connection; stiffened seat connection; and through-plate connection (with a design example).

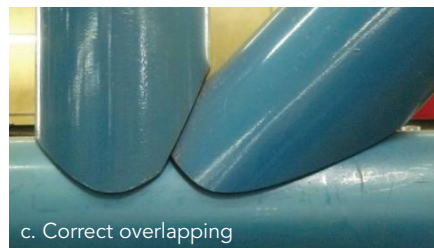
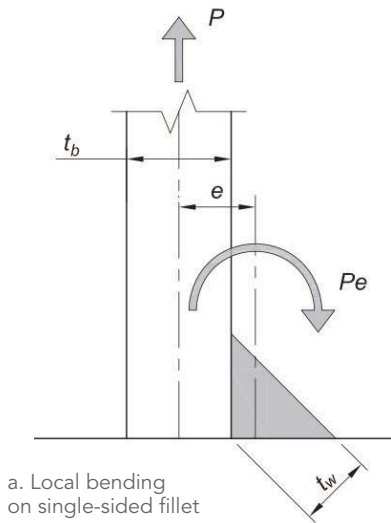

Fig. 4. Weld design and fabrication issues for HSS construction.

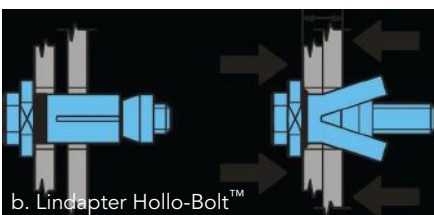

Fig. 5. Popular contemporary blind bolts.



Fig. 6. Single-plate shear connection to round HSS column.

Chapter 6 – Moment Connections describes six different options for wide-flange beam-to-HSS moment connections, most of which classify as fully restrained (FR). The simplest and most inexpensive option for a one-story building is a continuous beam over the HSS column, popular for big box stores (Figure 7). Other FR options presented are: the external diaphragm (cut-out) plate connection; welded tee connection; through-plate connection; and internal diaphragm plate connection. The directly welded beam-to-HSS column connection, which can be reduced to two transverse plate connections by considering only the flanges, is also included but normally only qualifies as a partially restrained (PR) connection. Design examples are given for all connection types except the internal diaphragm plate connection.

Chapter 7 – Tension and Compression Connections deals with welded and bolted connections to the ends of HSS members, under predominantly axial loading. The most common application of such connections is with bracing members in braced frames. Six common end connections to HSS members are presented, and three—the end tee connection (Figure 8), the slotted HSS-to-gusset plate connection, and the sandwich (or side) gusset-plated connection—are unique because they

cause shear lag in the HSS member due to non-uniform loading on the member end.

The end tee connection and the slotted HSS connection are prone to buckling of the gusset plate/stem under compression loading, so a design approach for this plate instability failure mode is also considered.

The remaining three connections are all bolted end-plate connections under axial tension: to round HSS with the bolts uniformly spaced around the tube; to rectangular HSS with bolts on just two sides of the HSS; and to rectangular HSS with bolts on all sides of the HSS. Design examples are given for a tee connection in both tension and compression; a slotted HSS-to-gusset plate connection in tension; an end plate-to-round HSS connection in tension; and an end plate-to-rectangular HSS connection with bolts on all four sides, loaded in tension.

Chapter 8 – Line Loads and Concentrated Forces on HSS is devoted to plates, welded transversely or longitudinally, to the wall of an HSS member. For

plate-to-round and plate-to-rectangular HSS, the connection types covered are transverse branch plate T- and cross-connections; longitudinal branch plate T-, Y- and cross-connections; transverse through-plate connections; and longitudinal through-plate T- and Y-connections.

Two possible limit states are presented for plate-to-round HSS connections, whereas six are used for plate-to-rectangular HSS connections (Table 8-2). For round and rectangular HSS cases, comprehensive available strength tables are given in a format based on connection type to supplement the partial coverage of plates-to-HSS in *Specification* Section K2. The relevant limits of applicability are now given for each limit state design equation, rather than as two collective groups (for plate-to-round HSS and plate-to-rectangular HSS). Three design examples round out the chapter: a longitudinal branch-plate and through-plate connection to a rectangular HSS; a transverse branch-plate connection to a rectangular HSS; and a wide-flange beam-to-round HSS column moment connection.

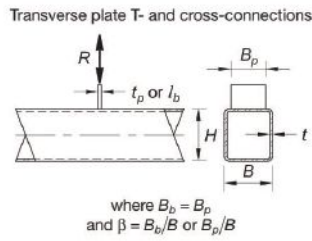

Fig. 7. Continuous beam over a square HSS column.

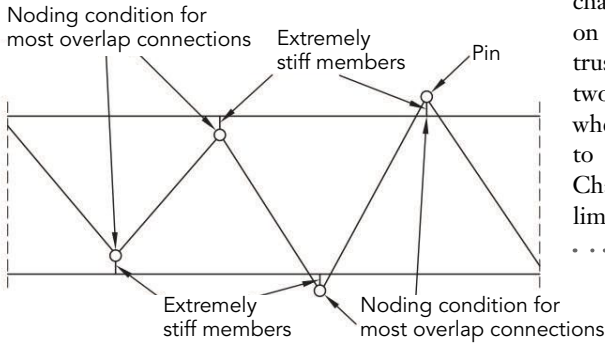

Fig. 8. End tee connection, with two stems, to a square HSS bracing member.

Table 8-2. Available Strengths of Plate-to-Rectangular HSS Connections				
Connection Type	Connection Available Strength ¹		Plate Bending ²	
	Plate Axial Load	In-Plane	Out-of-Plane	
Limit State 1: HSS plastification				
	$R_n = F_y t^2 \left[\frac{2t_p/B}{1-\beta} + \frac{4}{\sqrt{1-\beta}} \right] Q_t$ (2-2)	0		$M_n = F_y t^2 [X + Y] Q_f$ $X = \frac{0.5t_p(1+\beta)}{1-\beta}$ $Y = \sqrt{\frac{2BB_b(1+\beta)}{1-\beta}}$ (2-8)
$\phi = 1.00$ (LRFD) $\Omega = 1.50$ (ASD)				
Limit State 2: HSS shear yielding (punching shear)				
	$R_n = 0.6F_y t (2t_p + 2B_{op})$ $B_{op} = \left(\frac{10t}{B} \right) B_b \leq B_b$ (J4-3), (K1-2), (2-11), and (8-3a)	0		—
$\phi = 1.00$ (LRFD) $\Omega = 1.50$ (ASD)				
Limit State 3: Local yielding of the branch plate				
	$R_n = \left(\frac{10t}{B} \right) F_y t B_b \leq F_{yp} t_p B_b$ (K1-1), (2-14), (8-2a)	0		—
$\phi = 0.95$ (LRFD) $\Omega = 1.58$ (ASD)				
Limit State 4: Local yielding of the HSS sidewalls				
	$R_n = 2F_y t (7.5t + t_p)$ (J10-2), (2-17)	0		$M_n = 0.5(B-t)R_n$
$\phi = 1.00$ (LRFD) $\Omega = 1.50$ (ASD)				
Limit State 5: Local crippling of the HSS sidewalls				
	$R_n = 1.6t^2 \left(1 + \frac{3t_p}{H} \right) \sqrt{EF_y} Q_t$ (J10-4), (2-19)	0		—
$\phi = 0.75$ (LRFD) $\Omega = 2.00$ (ASD)				
Limit State 6: Buckling of the HSS sidewalls				
	$R_n = \left(\frac{48t^3}{H-3t} \right) \sqrt{EF_y} Q_t$ (J10-8), (2-23)	0		—
$\phi = 0.90$ (LRFD) $\Omega = 1.67$ (ASD)				



Format used for connection available strengths, by connection type and per limit state.



Chapter 9 – HSS-to-HSS Truss Connections, the longest chapter at 58 pages, concentrates on the special case of welded truss-type connections between two or more HSS members, where the branches are subjected to predominantly axial loading. Chapter 9 relies on the exposé of limit states described in Chapter

Fig. 9. Truss modeling using a continuous chord and pin-connected webs.

2 and probes connection parameters and layouts, how to classify connections (into types such as K, Y or cross), appropriate truss modeling for the service and ultimate limit states (Figure 9), round HSS webs-to-rectangular HSS chord members, KT-connections (with three web members), and multi-planar HSS members.

Connection available strengths, and their corresponding limits of applicability, are tabulated in a similar manner to Chapter 8 by listing and numbering every limit state for each connection type. Six design examples round out the chapter: two for round HSS (a Y-connection; and an overlapped K-connection) and four for rectangular HSS (a cross-connection; an overlapped K-connection; a gapped K-connection, with unbalanced branch loads; and an overlapped KT-connection).

Chapter 10 – HSS-to-HSS Moment Connections expands on *Specification* Section K4 and Chapter J, covering planar connections between round or rectangular HSS members in T-, Y- or cross-connections. Branches can have in-plane or out-of-plane moment loading (unlike truss-type connections where the branches have axial loading). A common application is in 2D or 3D frames, hence the requirements for HSS Vierendeel frames are pointed out.

The limit states for HSS moment connections largely follow those for their axially loaded counterparts in Chapter 9. Connection available strengths, and their corresponding limits of applicability, are tabulated in a similar manner to Chapters 8 and 9. Design examples are given for a round HSS cross-connection under branch in-plane bending; a rectangular HSS T- or Vierendeel connection under in-plane bending; a rectangular HSS cross-connection under branch out-of-plane bending; and a rectangular HSS T-connection under branch out-of-plane bending. ■

ABL-100HS
Angle Line

SHEAR COPIES
NOTCHING
MARKING
TRIPLE GAGE
PROBE MEAS
CUT PROFILE FLAT

Controlled Automation

The only angle & flat bar line holding the title for both toughest build quality and fastest speeds.

Controlled Automation

501.557.5109 | www.controlledautomation.com



Jeffrey A. Packer
(jeffrey.packer@utoronto.ca) is a structural engineering professor at University of Toronto.

Veteran Voice

INTERVIEW BY GEOFF WEISENBERGER

Prominent fabrication engineer Mark Holland's first employer is so far his only one—after four decades.



MARK HOLLAND came to Paxton & Vierling Steel (PVS) in 1983 as a recent graduate looking for a place to launch an engineering career. He joined the company thinking it would be the first stop on a long journey.

It turned out to be his only stop—which is fine by both parties.

Forty years later, Holland is still there and has risen to a leadership position as the company's chief engineer. He has become a respected voice in fabrication engineering. He has served on AISC committees, including his current roles as the chair of the

Committee on Manuals and chair of the Committee on Structural Stainless Steel. He also is a member of the Committee on Specifications and several subcommittees and task committees. He earned AISC recognition when he won a 2023 Lifetime Achievement Award for his years of service.

Holland spoke with *Modern Steel Construction* about his start in the industry, his career, how his mentors inspired him, and more.

What brought you into the engineering world, and how did you get where you are?

I became an engineer because I've always been mechanically inclined. I don't have any specific moment where I decided that would be my path. I think I was just born and destined to be this way. I was always a problem-solver and liked math more than anything else. All those things culminated and turned a person into an engineer. My wife will tell you that I am a true engineer, and I act like one every day of the week, all year long.

Did you start by studying civil engineering or structural engineering in school?

When I went to school, I initially wanted to get into architectural engineering. Two classes I took my first semester at the University of Oklahoma were architecture and engineering, and I quickly realized that to be an architect, you have to have some degree of artistic ability. I have none. I quickly dropped the architectural portion and stayed in engineering.

Did you go into the design world before going to PVS?

No. When I finished my undergraduate degree, revered Oklahoma engineering professor Tom Murray had just finished building his first lab on campus, the Fears Lab. He wanted to staff it with some people that he thought could help him in the lab and help it grow. He knew I was mechanically inclined from my classes with him, so he invited me to stay there and get



Field Notes is *Modern Steel Construction's* **podcast series**, where we interview people from all corners of the structural steel

industry with interesting stories to tell.

Listen in at modernsteel.com/podcasts.

a master's degree under him. I stayed there and helped Tom with the Fears Lab.

Was it straight into the fabrication world after that?

When I was finishing my master's, the country was in recession. I was on a business trip with Tom at Nucor in Norfolk, Neb. He took me by PVS knowing I was sending out résumés and getting rejected right and left because nobody was hiring more engineers that year. I was fortunate enough to talk to the folks at PVS. They knew Tom well and they liked me.

I had done some work for a guy named John Griffiths, who was the vice president of engineering at PVS. They had done some research at the Fears Lab, and I had helped set up the test specimens and solve problems while John was watching me.

John was impressed that a guy could crawl out after putting a bunch of steel together, get up, wash his hands, fix a problem on a computer, and then go back to tightening a bolt. He thought that was a handy skill set for a fabricator. When Tom told him I was looking for a job, he offered me a job at PVS.

What was your role and title at the beginning with PVS?

It was a sales engineer role. The idea was to promote structural steel locally. I started when AISC still had regional engineers driving around the country. My role was to work with them and, like them, promote structural steel.

One thing that PVS did—and I'm not sure how many fabricators do it anymore—was when I started there, I worked in the office for about a month to get to know people. Then they put me in the shop to learn how the shop worked. I worked in the shop for about a year doing all the fabricator chores, from handling material, cutting the material, trying to weld, trying to fit, and running the blaster.

They worked me through each one so I could experience life on the shop floor as a steel fabricator. After that, I went back to sales engineer. Later, PVS needed a QA Manual, so I wrote that. I also helped them get through the auditing program.

You're a go-to for fabrication engineering. How did that come to be?

Tom Murray and I were in the Fears Lab one Friday afternoon, and he gave me some helpful and wise advice. He said if I really wanted to understand structural steel and want to be a good steel engineer, I had to work for a fabricator sometime. Maybe he forgot to tell me that sooner or later, I should leave and go do something else. I clearly didn't get that part, because I've been here 40 years.

What project in your 40 years has been particularly memorable, one way or another?

Most of them will drive you crazy, because that's how the industry works. But some of our nuclear projects were among the most interesting. In the mid-1990s, a PVS customer gave us a global contract, and we worked offshore from about 1995 to 2000. In that span, we exported most of our fabricated tons to China, Indonesia, and India. We went back and forth across the Pacific Ocean to see those projects. So that was always very interesting.

Right now, I'm working on a job that every engineer at a steel fabricator would probably want to do: the second mobile launch tower for NASA for the Artemis program at the Kennedy Space Center.

NASA launched the first Artemis rocket in January 2023. Two more rockets go off that tower, the Mobile Launcher 1. The Mobile Launcher 2 is for the bigger vehicles, and that's what we are building.

NASA is a very science-based customer with extremely smart people. They can ask challenging questions that we have to answer. It's a challenging job, and it was very schedule-driven because the rocket has to go off that tower on a set date and the tower has to be ready. It's the first time we have done any aerospace work.

You do a lot of mentoring work. What's your philosophy with mentoring, and what has your experience been with it?

I'm paying the world back. Tom Murray and John Griffiths were my mentors. I was very fortunate to have people who took an interest in me, saw potential in me, and were willing to spend time bringing me into the industry and teaching me things you don't learn in class.

You can only learn from someone who wants to mentor you. I benefitted from it,

and when you have that opportunity, it's only right to pay it back. I've had some young people come to PVS to work for me or with me, and I've tried to help them understand the industry better and learn how to interact with people in the industry.

If you have an opportunity, and if you have experience and knowledge, it's our responsibility as engineers to mentor as much as we can. We need that. We need to bring the next generation along and make them successful because we will turn things over to them. We need to make sure they're ready. It's very rewarding.

On the fabrication shop side, how have you experienced the challenges of hiring welders and fitters?

We have experienced that. As a company, we've started a mentoring program at a local high school where students weld at school and work in our shop a couple of days per week. They get class credit for that. If we keep them and they like the work, we'll likely hire them. We've hired five or six of them and put them in the shop. They've turned out to be good welders because we trained them from scratch.

It's a mentoring program to encourage people to weld, not necessarily to require them to come to PVS when they graduate. But if they feel a bit of an obligation to stay, we're lucky to pick them up and keep them. If you bring them to the shop and get them interested in welding at an early age, they tend to want to hang on to it.

Welding is an excellent career path if you don't want to or can't go to college. If you build welding skills, you will always have work. And you're physically building something, so that's rewarding as well.

Have you implemented any robotic welding arms or automation?

We had a robotic welder for a while. But our market is typically industrial, so there are never too many identical parts.

What I learned with our robot was that you have to plan how you're going to load it up when you're detailing it. You can't do it after it has already been detailed. You must have a way of routing that material to the robot through first-step processing to that machine. You have to think about the kind of connections that the machine can actually do. It does many connections, but

field notes

it does some well and more efficiently than others. You have to think about connection design and routing of the material.

If we focused more on that type of work and were less focused on the industrial market, we might have kept it. But for fabricators who do commercial work with a lot of repetition and identical parts, if you can get ahead of the technology, think about implementing it as you think about detailing and connection design, those automation tools will help solve the labor problem.

That's true for shops where about 80% of the beams and columns they fabricate are usually typical and common. The other 20% need a skilled fitter. But if you can take care of that first 70 or 80 percent using robotic welding, it frees up labor to do the more complicated stuff. That's the plan steel fabricators must figure out how to execute better. Companies are putting these tools in front of fabricators. We're just having some trouble implementing them.

For example, a fitter is one position we sometimes have trouble filling. You can make the machine a fitter, not a fitter and a welder, and have a team of welders doing the final welding. That's a good way to use those tools. But you have to start from the beginning. You have to have somebody in the organization who's dedicated, believes in it, and wants to see it work. If we do all those things together, I truly believe that technology would be helpful and successful. ■

This article was excerpted from my interview with Mark. To hear more from him, find the April 2024 Field Notes podcast at modernsteel.com/podcasts.



Geoff Weisenberger
(weisenberger@aisc.org) is the editor and publisher of *Modern Steel Construction*.



6-Axis Robotic Structural Steel Profile Cutting

With our Beamcut System 3D Robotic Profile Cutting Machine, you can cut virtually any shape on mild steel, stainless steel, and aluminum. Exceptional repeatability and accuracy using our technology and software. Equipped with Hypertherm high-definition plasma and Fanuc Robotics. Eliminate costly layouts and time-consuming grinding. Simplify your fabrication process. Minimize errors. Increase production speeds. Find out more:



BEAMCUT SYSTEMS™
Part of the Machitech Automation Group

Call Toll-Free: 1 (833) 232-6288
Web: beamcut.com • machitech.com

For more Info or a Quote, visit
www.beamcut.com/structural
Or scan the QR Code



ST. LOUIS
SCREW AND BOLT



ENJOY THE SAME GREAT SERVICES

- ◆ OVER-THE-TOP WRAPPING
- ◆ PALLET MAPPING
- ◆ HEXPORT®
- ◆ RPK® - RIGID POLYETHYLENE KEGS
- ◆ ONE & TWO DAY SHIPPING NATIONWIDE

Call or email us your inquiry!
St. Louis Screw & Bolt

sales@SLBolt.com
800-237-7059

Connecting amazing structures Nationwide!

ATLANTA ◆ LAS VEGAS ◆ ST LOUIS

Deciding on Delegated Design

BY EDWARD SEGLIAS

Delegated design can work for many projects, but understanding the risks beforehand is crucial.

EMBARKING ON ANY new project poses financial risk, operational challenges, and myriad decisions about design and construction to achieve project success. Sometimes, though, project success is at risk because the traditional project delivery alignment means the project team is siloed, with the design professionals standing on one side of the owner and the contractors and subcontractors on the other.

This traditional project delivery method has a long record of success. But it also has its limitations. As a result, innovative collaborative techniques have evolved to address the complexities of large, fast-paced projects and improve efficiencies in design and construction.

One newer technique is delegated design.

Under this approach, the project's design professional transfers design responsibility for a specific portion of the work through the owner and general contractor to a specialty contractor. The transfer must include a proper description of the performance criteria for the work and requires the specialty contractor to employ its own design professional to ensure the design and subsequent work meet the performance criteria established by the design professional. It's not a project delivery method and, therefore, can be integrated into most delivery methods.

Delegated design is routinely found in a variety of trade specialties, including fabrication of structural steel and its related components. For example, mechanical and electrical designs can benefit from delegating a portion of work to a specialty contractor. Similarly, curtain wall or building envelope design are frequently delegated to special contractors and structural steel connection design has been delegated to fabricators. All those delegations require the specialty contractor to engage an engineer to prepare and submit sealed design documents to ensure the contractor has provided the proper level of engineering design.

The American Institute of Architects (AIA) and AISC addressed the benefits and limitations of delegated design (and design assist) in an August 2020 jointly released collaborative document: *Delegated Design, Design Assist, and Informal Involvement—what does it all mean?* The organizations

published Part II, *Design Assist—Collaborative Design Approach Guidelines for the Fabricated Structural Steel Industry*, in February 2024.

The 2020 AIA/AISC paper explains that delegated design is a form of collaboration between a design professional and a contractor where the contractor assumes responsibility for an element or portion of the design. While the design professional and contractor typically have separate contracts with the owner establishing their respective design responsibilities, the contractor will be responsible to the owner for that portion of the design delegated to it.

However, the design team does not release its overall design responsibility simply because some part of the design has been delegated to the contractor. Rather, the design professional remains responsible for the adequacy of the performance criteria delegated and to the owner to assure that the delegated design complies with the project's overall needs. Unlike design assist, delegated design usually occurs later in the design process, whereas design assist occurs early to help set parameters for the project design.

The *Code of Standard Practice for Steel Buildings and Bridges* (ANSI/AISC 303-22) also weighs in on the issue. *Code* Section 3.1.1 (3) says the design professional is permitted through the design documents or specifications to delegate connection detail design to a licensed engineer working for the fabricator.

From there, and consistent with the AIA/AISC paper, the fabricator must submit representative samples of the connective information to the owner's designated representative for design (ODRD), which then must confirm the samples are consistent with the specific connection design criteria and that the sample information meets the needs of the project.

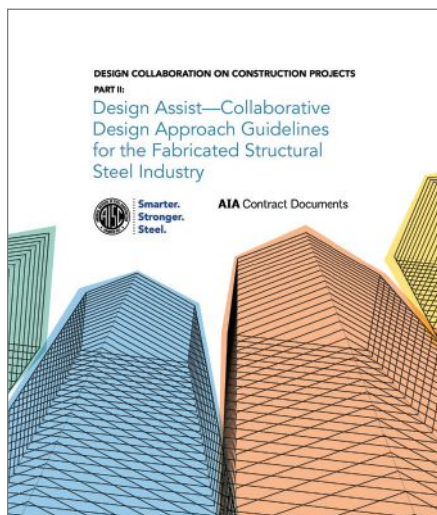
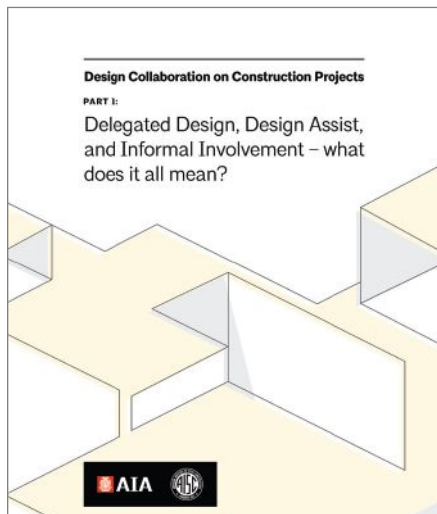

The benefits of delegated design are obvious from the owner’s perspective. Because specialty contractors have their own way of planning and performing work, participation in the design process allows them to control their work more effectively. The result should be fewer cost overruns and scheduling disruptions, thereby enhancing efficiencies and cost savings.

The downside, though, is if the collaboration effort is not executed in a manner benefiting all members of the project team.

For example, vague or inarticulate contract language relating to design parameters and design coordination can lead to misunderstanding and error. Thus, while a portion of the design may be delegated to a specialty contractor, the design professional is still responsible for assuring a clear set of design criteria for the work is conveyed to the specialty contractor and reviewing the design submissions to confirm conformity with the criteria.

The specialty contractor must similarly understand the design professional’s design parameters and expectations and coordinate its efforts with the design professional and general contractor to complete its design responsibility successfully. Communication between these constituent parties is key. Minimizing, if not eliminating, mistakes stemming from miscommunication or

misunderstanding should be a primary goal of the project team. Failure to meet that goal can undermine delegated design’s benefits or, worse, cause failure of the system.

Some states also have placed limits on delegated design through codes, regulations, and case law. For example, following the Kansas City, Mo., Hyatt Regency walkway collapse in 1981, an appeals court held that some elements of project design, such as the design of the primary structure, simply cannot be delegated to a specialty contractor. Similarly, New York’s state code permits design delegation only for components ancillary to the main components of the project. Specialty contractors may still be able to provide design suggestions, but they need to be reviewed, verified and accepted by the project design professional. In Florida, the state Administrative Code under Chapter 61G15-30 sets forth requirements for the EOR and the delegated EOR concerning the delegation of engineered documents.

Today’s construction environment has created a need for the involvement of specialty contractors to engage with design professionals early in the design process. Project teams recognize their expertise and experience as a valuable asset, which likely will contribute to improved efficiencies and cost savings.

But these efficiencies and cost savings are dependent on a proper description of the delegated design parameters and the establishment of a working relationship that promotes effective communication and collaboration between the owner, design professionals, and contractors. Assuming these baseline conditions can be met, delegated design of certain portions of the work may be right for your project. ■

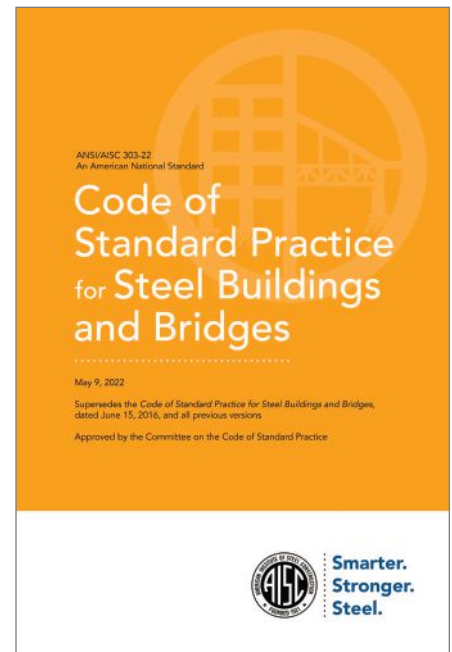

AISC, AIA Release Part II of Design Assist Guidelines

Everyone is talking about collaboration these days, but is everyone on your project team defining it the same way?

AISC and AIA Contract Documents have released the second part of a document intended to provide guidance for three common strategies: informal involvement, design assist, and delegated design. Part II focuses on the implementation of design assist in the fabricated structural steel industry.

“Great teams drive great projects—and great teams rely on clear communication,” said Dave Steel Company, Inc. VP of Special Projects Babette Freund, who chairs AISC’s Code of Standard Practice Committee. “This paper aims to help project teams use

design assist strategies to meet a defined project schedule and budget while minimizing the costs and disruptions that might arise from team misalignments.”

Design Assist—Collaborative Design Approach Guidelines for the Fabricated Structural Steel Industry describes the roles and responsibilities of various project participants and provides general guidelines about applying those strategies to fabricated structural steel projects.

The paper addresses Design Assist and Delegated Connection Design as applied to the fabricated structural steel industry. It was written by AISC with significant contribution from the Code of Standard Practice Committee and a review by AIA Contract Documents. Members of the AIA Contract

Documents content development team reviewed Part II for general conformance with the principles set forth in Part I, which addressed the three common collaboration strategies in detail.



Edward Seglias (eseglias@cohenseglias.com) is AISC’s General Counsel and the co-CEO of Cohen Seglias. He specializes in construction law.

Energy Efficient

BY JEFFREY CHAN, PE, SHAMIL LALLANI, AND FLORIAN MEIER, PE

Dramatic steel cantilevers and an innovative façade design help an energy research laboratory save energy.



The common overlapping areas of the varying floors are an approximately 170-ft by 82-ft parallelogram.



THE UNIVERSITY OF PENNSYLVANIA is expanding its facilities dedicated to energy research with the new Vagelos Laboratory for Energy Science and Technology (VLEST). The new building, located on the east side of campus near downtown Philadelphia, will house current and future energy research programs and laboratory spaces shared between the School of Arts and Sciences and the School of Engineering and Applied Science.

The 112,000-sq. ft VLEST has a 1,600-ton structural steel frame and includes seven floors of research laboratories, workstations, collaborative spaces, and faculty offices. It sits on a former parking lot between the David Rittenhouse Laboratory building to the west and South 32nd Street to the east, aligning with the street and creating a new landscaped quad with the neighboring campus buildings.

A lowered Philadelphia SEPTA train line runs on the other side of 32nd Street, and nearby train traffic made noise and vibration key considerations when designing the lab spaces and supporting structure. On-site vibration studies informed the strategic location of the more sensitive laboratory equipment.

The design team initially considered both concrete and steel structural systems, but chose steel because it achieved the building's cantilevering form and local steel bidders were more plentiful.

.....

opposite page: The new Vagelos Laboratory for Energy Science and Technology incorporates passive, low-energy strategies in its massing and façade design.

Building Form and Structure

The building's unique architecture is a result of Behnisch Architekten's early collaboration with engineers and consultants to integrate sustainable ideas and energy efficiency, aligning with the research institute's core mission. The building's form responds to the complex site and incorporates passive, low-energy strategies in its massing and façade design, which are informed by sun path and orientation.

The typical building floorplans are organized as parallel bars, with laboratory space on the east side and collaborative spaces, offices, and interconnecting stairs on the west. While there are no repeating floorplates, the common overlapping areas of the varying floors are an approximately 170-ft by 82-ft parallelogram. The architectural design rotates and extends half of the floorplate in two-story packages, creating angular, dynamic cantilevered volumes on the north and west sides of the building.

The shifted floorplates are achieved with cantilevered wide flange sections of the floor framing, which cantilever up to 25 ft. The cantilevered floor beam solution allows for a simplified structure with interior spaces unobstructed by diagonals had trusses been used, while also reducing fabrication costs. Steel wide flange columns are arranged on a 22-ft by 28-ft grid, taking lead from 11-ft-wide laboratory modules.

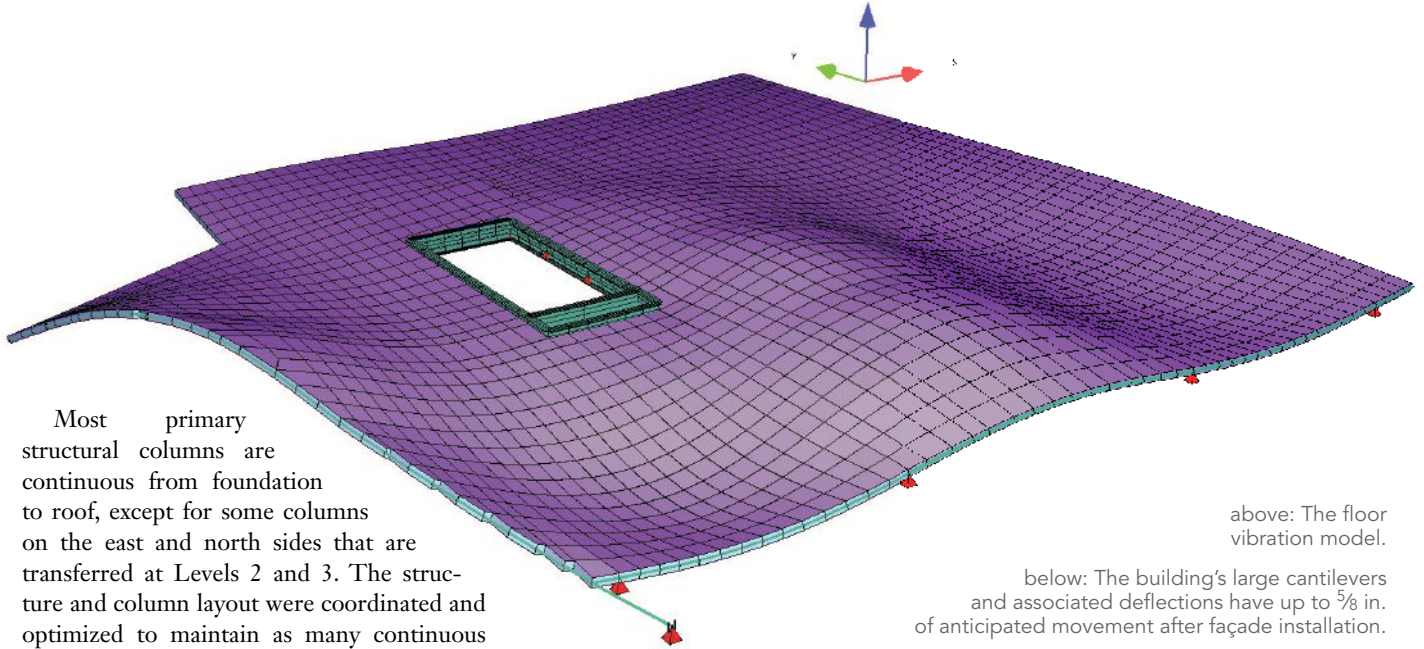

above: The floor vibration model.

below: The building's large cantilevers and associated deflections have up to $\frac{5}{8}$ in. of anticipated movement after façade installation.

Most primary structural columns are continuous from foundation to roof, except for some columns on the east and north sides that are transferred at Levels 2 and 3. The structure and column layout were coordinated and optimized to maintain as many continuous columns as possible, achieving the complex architectural form while simplifying the structure and keeping structural costs down.

At the northwest corner of Level 7, a pair of heavy W36×487 girders cantilever west and create a 25-ft overhang. The backspan of one girder meets at an acute angle with another cantilever spandrel beam at a common column.

Structural engineer knippershelbig and fabricator Berlin Steel decided the two backspan pieces would be fabricated and lifted together. The resulting 21,400-lb joined piece was the heaviest pick on the project. From Level 7, exposed rectangular hollow structural system (HSS) hangers suspend the Level 5 floor structure below, resulting in a double-height space and a dramatic overhanging volume on the building's west side.

Aligning building movements with the façade is always critical to a successful building project, and the VLEST is no exception. The building's large cantilevers and associated deflections were carefully coordinated for compatibility with façade joints and have up to $\frac{5}{8}$ in. of anticipated movement after façade installation.

To meet the acoustic transmission targets of the laboratory spaces, Vulcraft 3VLP acoustic metal deck was used as part of a 7-in. composite deck floor system on the east portions of the floorplans over the laboratories. The remainder of the typical floors consist of conventional 4-in. lightweight concrete slab over 3-in. metal deck. Radiant heated floors were used in the shared and collaboration spaces in isolated areas on occupied floors.

The radiant tubing was embedded directly within the structural 4-in. concrete slab on 3-in. metal deck. The embedded radiant tubing was coordinated to be above the 4-in. tall studs within the concrete slab on deck,

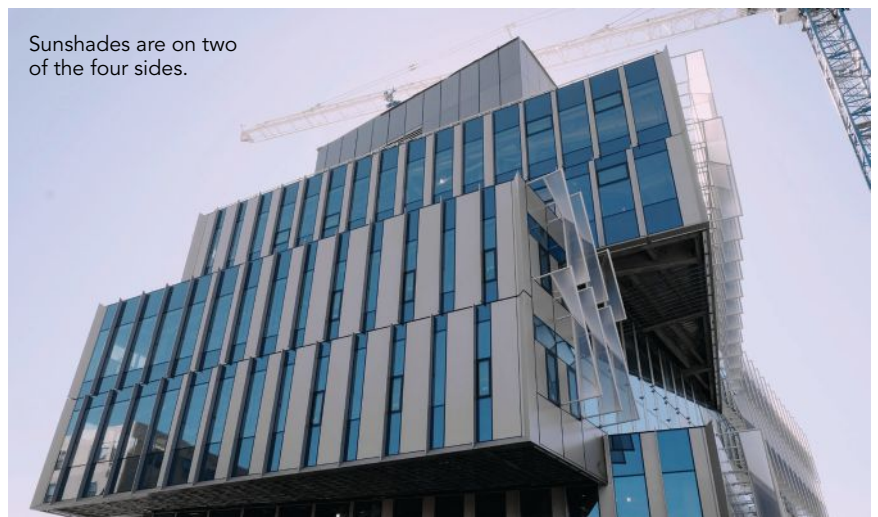

Sunshades are on two of the four sides.



At Level 7's northwest corner (pictured), two W36x487 girders cantilever west and create a 25-ft overhang.

.....

allowing for greater flexibility of tubing clear distances from studs without compromising composite action.

Limiting the floor structure's vibration is essential for sensitive laboratory equipment to function properly. The steel floor structure is designed to limit the vibration velocity of specific floor areas with a mix of VC-A (less than 2000 mips) for laboratories on the elevated floors and VC-D (less than 250 mips) for high-performance labs on the ground floor.

A dynamic analysis was performed using finite element analysis methods of the critical floor areas to design the beams for vibration limits. Floor vibration analysis was performed according to AISC Design Guide 11: *Vibrations of Steel-Framed Structural Systems Due to Human Activity*, 2nd Edition.

Five monumental stairs join adjacent floors from Levels 1 through 6. The interconnecting stairs and the resulting double height atriums link the open collaboration spaces upwards between the floors. The stringers of all the stairs, including those with up to 127° turns at the landings, span from floor to floor without intermediate posts or hangers at the landings. Vibrations and vertical accelerations under descending occupants often control the stair design for turned stairs with floating landings. Stair dynamic analyses and floor framing stiffness and connectivity were coordinated with stair structure to meet Design Guide 11's vertical acceleration criteria.

Steel ordinary concentric braced frames surround the building's two stair cores and one elevator core, resisting the building's lateral loads. The east-west lateral system is 11.3 ft, a short distance compared to the building's 136-ft height. The slender braced frames resulted in significant column net uplift at the foundation under lateral loads.

Two mat slab foundations up to 42 in. thick distribute the building's overturning under lateral loads and eliminate the need for any foundation tension elements to resist net uplift. To resist concrete breakout of the mat foundation, the columns' anchor rods with net uplift extend down near the bottom of the mat, and vertical reinforcement was added in the surrounding breakout zone.

.....

A closer look at one of the W36x487 backspan girders.



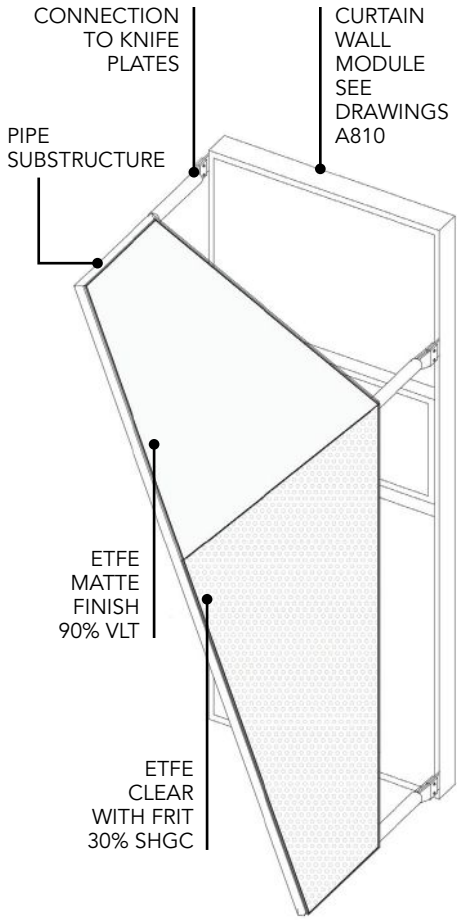

Façade diagram view 1 (above) and view 2 (below)

right: Sunshades are on five levels of the building façade.

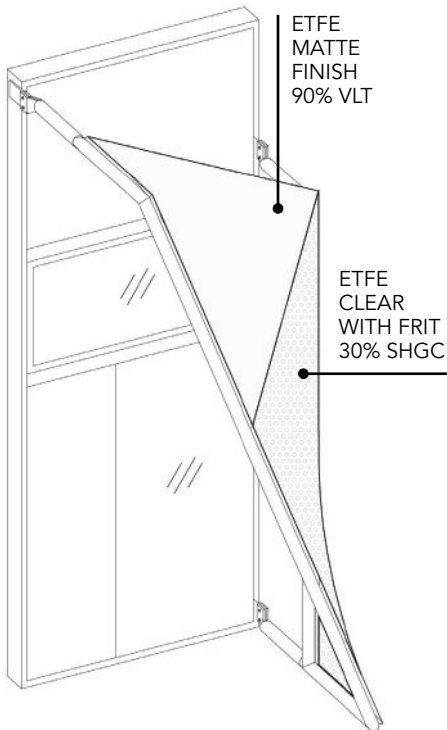

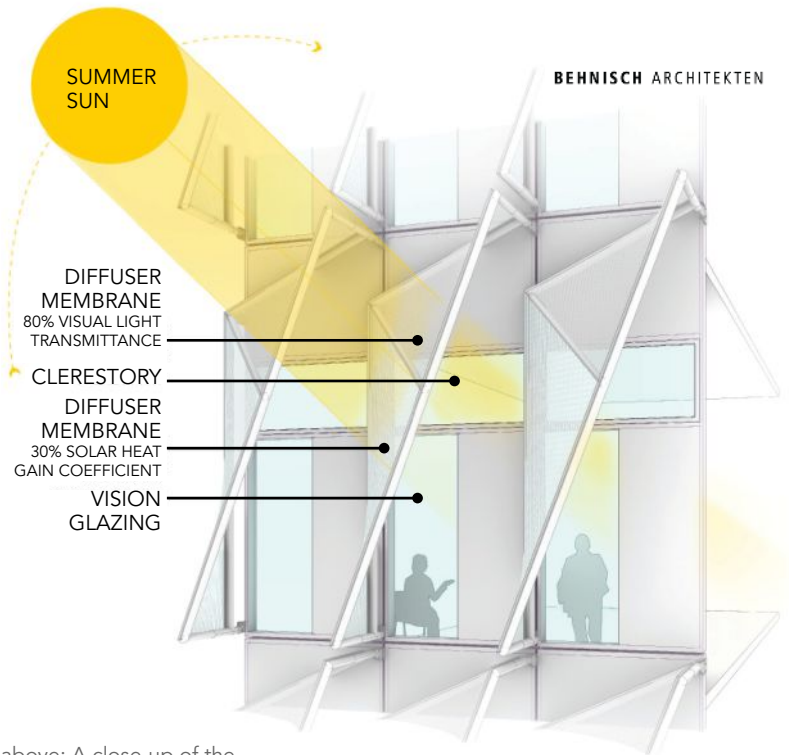

above: A close-up of the sunshades.

left: The façade diagram.

Façade Sunshades

The striking building exterior features a curtainwall with a screen of 267 sunshades on the east and west elevations. The Ethylene Tetrafluoroethylene (ETFE) membrane shades lower the energy needed to cool the building and diffuse daylight to reduce glare. Each shade consists of two ETFE panels heat-welded together—an upper 80% VLT light diffuser membrane and a lower 30% SHGC sunshade membrane—stretched across a 3-in. diameter powder-coated steel tube frame with a perimeter keder rope clamped into aluminum extrusions.

Sunshade geometry was developed through multiple iterations of form-finding to achieve good double curvature for efficient membrane action while also optimizing solar coverage and direction and contributing to the building’s performance-driven architectural expression. The design team made a special effort to implement the shades modularly within a unitized curtainwall system for cost-efficiency and constructability.

Each shade frame connects to a curtainwall unit’s mullions at three points via stainless steel knife plates, which are flipped and offset between adjacent units to achieve continuous diagonal sightlines along the elevations—despite stack joint interruptions.

The aluminum curtainwall mullions are steel reinforced to carry extra loads from the shades, which extend 5 to 6 ft from the façade. Installing units below overhangs and cantilevers was considered, as were strategies for façade cleaning and maintenance. The steel tube frames arrived on site shop-attached to curtainwall units. They were lifted together and attached to the building at depressed curtainwall embeds at the edge of slab on deck.

Due to consistent coordination and collaboration between the design and construction teams, the VLEST is nearing an on-schedule end to construction and is scheduled to open in fall 2024 as a cutting-edge energy laboratory—in practice and design. ■

Owner

University of Pennsylvania

Architect

Behnisch Architekten

Structural Engineer, Façade Consultant

knippershelbig

General Contractor

LF Driscoll Co.

Steel Fabricator, Erector, and Detailer

Berlin Steel Construction Company



Jeffrey Chan

(j.chan@knippershelbig.com) and

Shamil Lallani

(s.lallani@knippershelbig.com) are senior associates, and **Florian Meier** (f.meier@knippershelbig.com) is a director, all with knippershelbig.

A Bet on Steel

BY JOE PORADA, SE, PE, KEVIN JACKSON, SE, PE, AND CHRIS PORST, SE



A new sportsbook adjacent to Wrigley Field showcases steel's ability to integrate into an existing structure.

THE LATEST ADDITION to the Wrigley Field campus was among the trickiest to execute.

The new DraftKings Sportsbook—which opened for food and beverage service in June 2023—follows the 1060 Project, a multi-year \$1 billion restoration and expansion of the Chicago Cubs' historic home ballpark. The 1060 Project focused mainly on restoring the 100-year-old ballpark, adding fan amenities and expanding the Wrigley Field campus. Building the sportsbook, though, meant adding a structure to the iconic stadium.

The sportsbook is situated on a triangular-shaped site between Wrigley Field to the north and west, Addison Street to the south, and ballpark entry and exit gates along Sheffield Avenue to the east. It's a three-story structure that packs a lot of functionality into a compact 9,400 sq. ft footprint with 279 tons of structural steel. Its massing and aesthetic matches Wrigley Field's exterior and was approved by the National Park Service long before it was envisioned as a restaurant or sportsbook, meaning no major alterations could be made to its exterior for its interior transformation.

Structurally designed by Thornton Tomasetti, the sportsbook occupies the ground and second floors. Those floors also include a kitchen, back-of-house circulation, and offices. The east end features a large two-story space anchored by a 2,000 sq. ft wraparound video screen visible with sightlines from each seat in the sportsbook. The second-floor balcony is raked to provide similarly unobstructed sightlines. Hiding below the ground floor is an 18,000-ft³ concrete detention tank.

The roof serves as a terrace extension of Wrigley Field's upper concourse with additional public space, concessions, and restrooms housed in the mechanical penthouse. The roof structure consists of steel trusses spanning nearly 70 ft north-south over the width of the site.

New Meets Old

One of the project's primary challenges was coordinating the new sportsbook structure with Wrigley Field. The new spread footing foundations, ground floor slab-on-grade, steel column

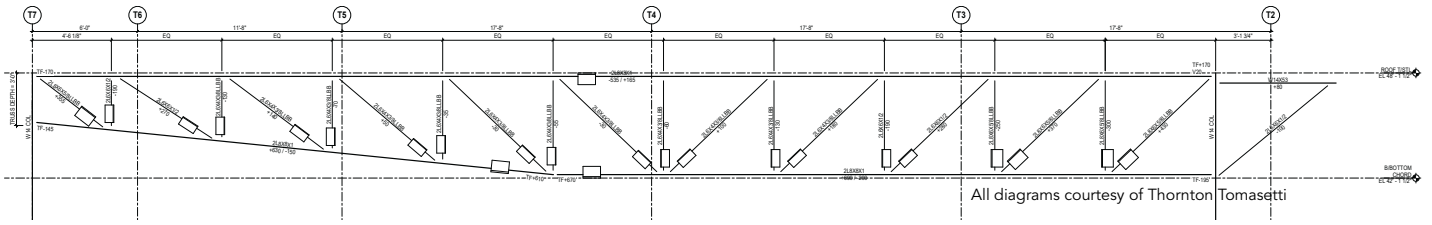

All diagrams courtesy of Thornton Tomasetti

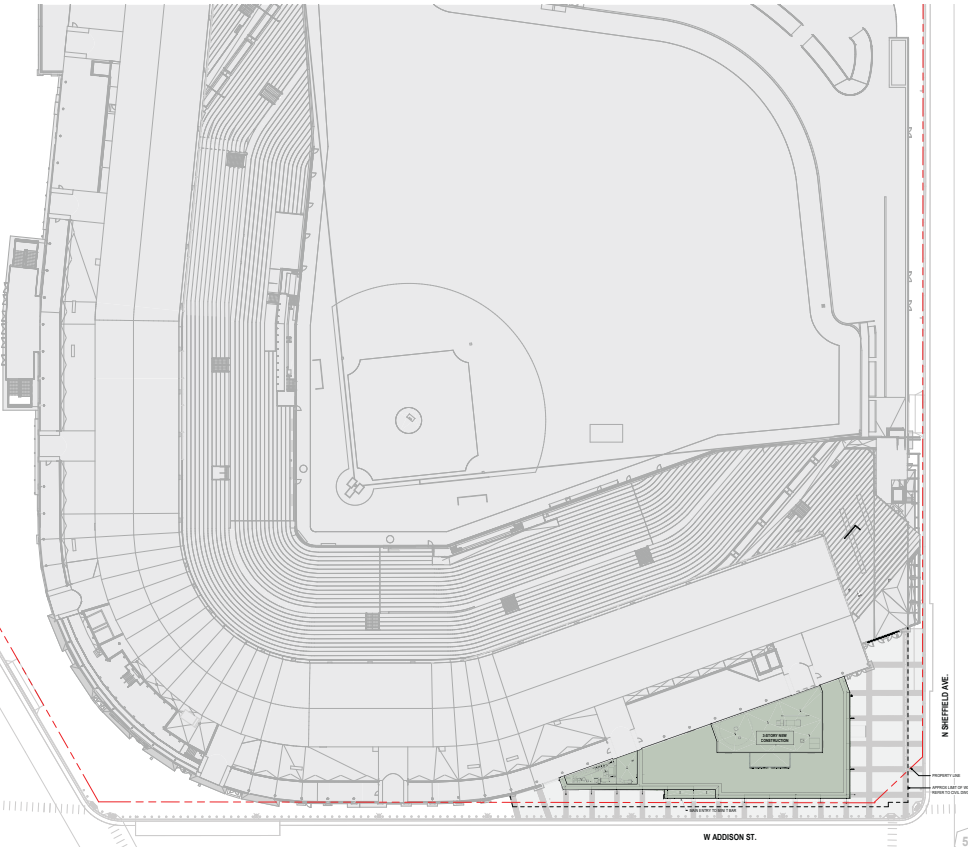

above: The roof truss elevation with a sloping bottom chord to maintain video screen sightlines.

opposite page: The finished DraftKings Sportsbook.

left: The triangular-shaped sportsbook site in the context of adjacent Wrigley Field.

below: Second-floor framing plan with the structure's triangular geometry.

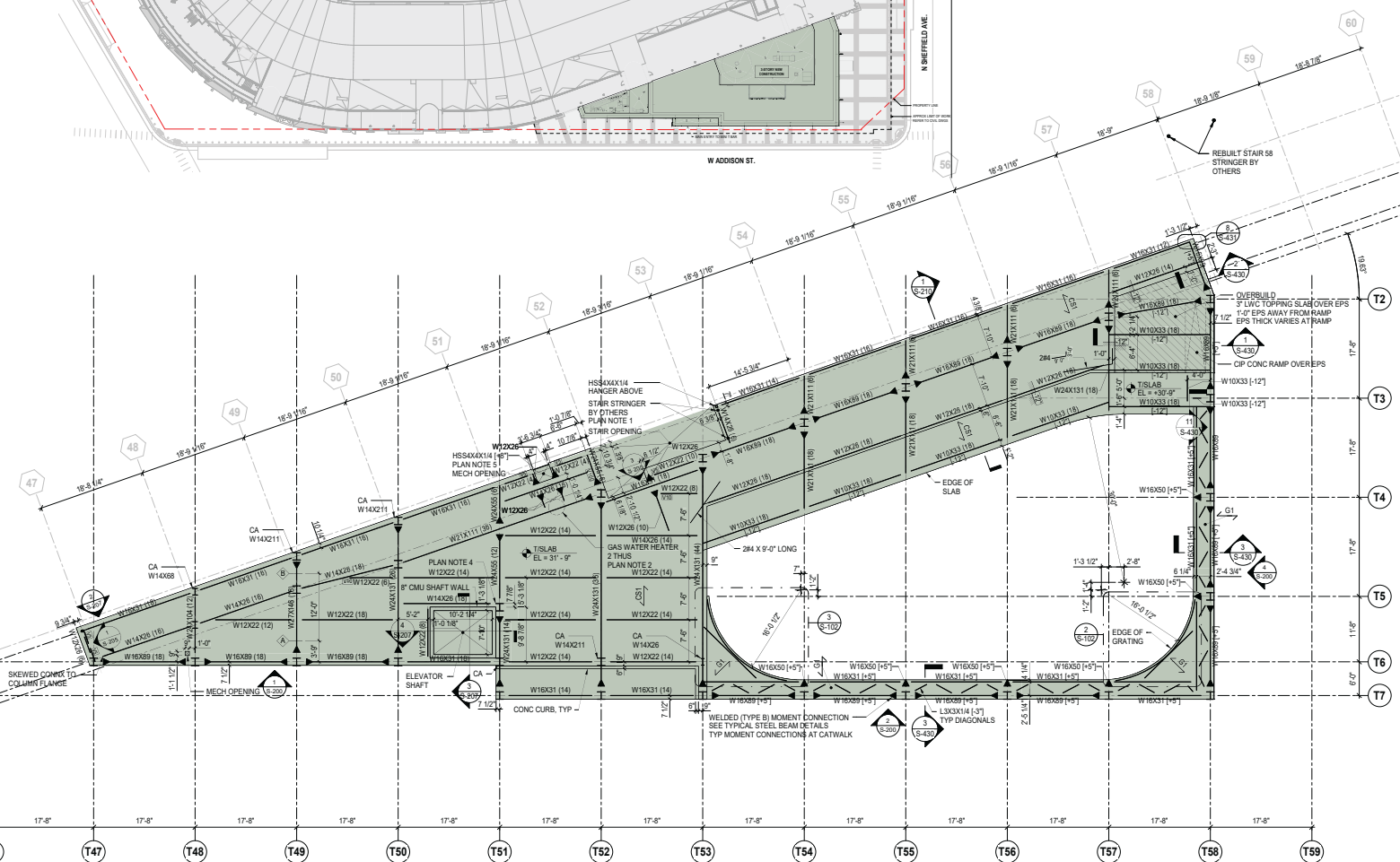

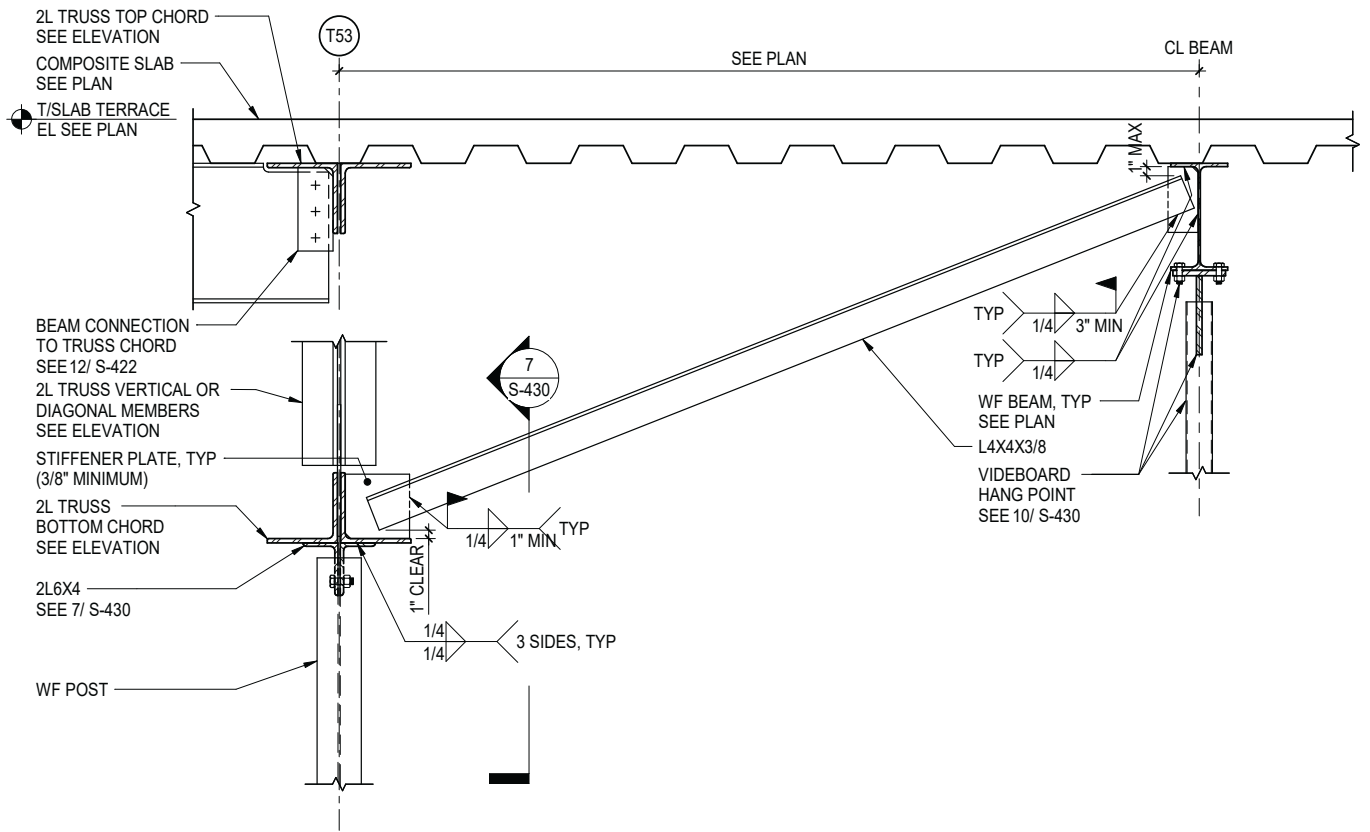

6 KICKER CONNECTION AT WF POST DETAIL

SCALE: 1" = 1'-0"

Detail showing the kicker bracing of the truss bottom chord and the hanging support point for the video screen.

locations, and steel framing at the expansion joint between the sportsbook and ballpark all required careful coordination with the existing documentation and as-built drawings from the 1060 Project.

Fortunately, the project team at Thornton Tomasetti that worked on the design of the sportsbook also worked on the 1060 Project. That experience helped the team build the sportsbook and detention tank adjacent to the ballpark foundations with varying bottom-of-footing elevations without undermining the existing structure.

Structural steel was a natural choice for several reasons. Primarily, the triangular site introduced building geometry challenges that steel framing could overcome. With the ballpark directly adjacent to the sportsbook, the building columns were set back from the edge of the slab, creating a 10-ft cantilever to the north. Additionally, the two-story seating space featuring a raked balcony required 17-ft cantilevers to the south off the same columns. Structural steel achieved the double cantilever with limited deflection and vibration.

The sportsbook was designed shortly after the Chicago Building Code was revamped to require seismic design considerations for all structures. Although the site's location defined the building as moderate seismic risk in SDC B, the building's triangular geometry caused the structure to be torsionally irregular.

Furthermore, the setback from the existing ballpark triggered a vertical irregularity in the seismic force resisting system, and the large floor opening at the second-floor balcony resulted in diaphragm discontinuity and weak story irregularities. The low self-weight of structural steel and limited seismic risk in Chicago helped the team design for those structural irregularities. Steel's low self-weight also allowed the foundations to be shallow spread footings and avoid more expensive deep foundations.

Structural steel also allowed the framing to be delivered, staged, and erected in the middle of the 2022 baseball season. Deliveries were made and staged on the east end of the site along Sheffield Avenue, and contractor Pepper Construction orchestrated careful scheduling of these deliveries to avoid overcrowding the confined site and conflicting with Cubs games.

Major deliveries and site activity were limited on game days, on which Pepper was required to shrink the site by temporarily restoring the pedestrian sidewalk for fans along the site's southern edge. The steel erection was divided into four sequences, beginning with the framing for the two-story space at the east end, followed by the mechanical penthouse above, and finishing with the west end.

Pepper used a 260-ton crane to set the two easternmost trusses, a 240-ton crane to set the remainder of the two-story space and mechanical penthouse, and a 60-ton crane for the west end.



Thornton Tomasetti

The sportsbook roof allowed for a terrace extension of Wrigley Field's upper concourse.



Thornton Tomasetti

The detention tank beneath the sportsbook ground floor.



The ground floor under construction.

Pepper Construction

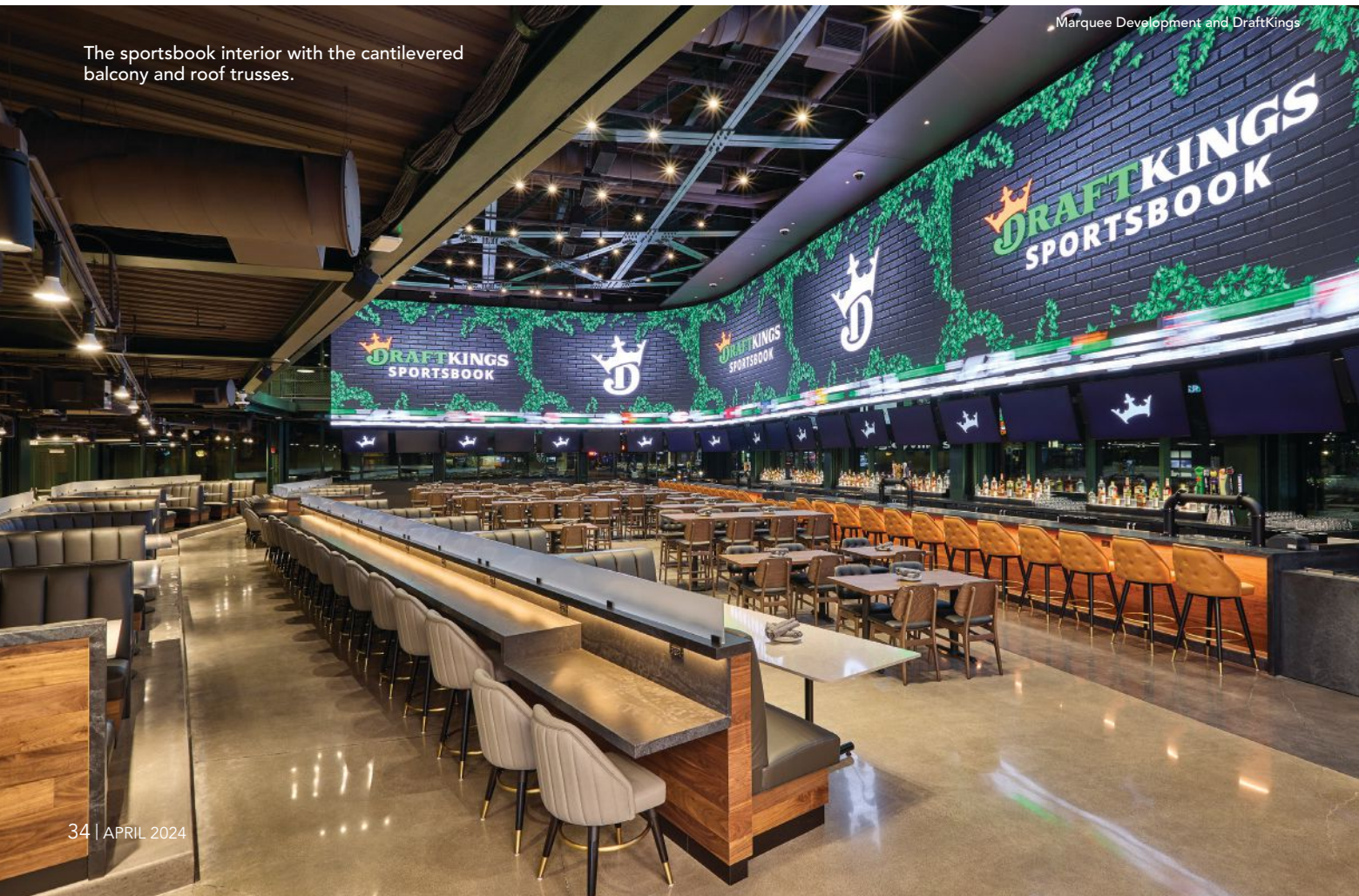

The sportsbook interior with the cantilevered balcony and roof trusses.

Marquee Development and DraftKings

CHICAGO METAL ROLLED PRODUCTS

Saved \$24,000 of Weld Splices with One-piece "S" Curves.

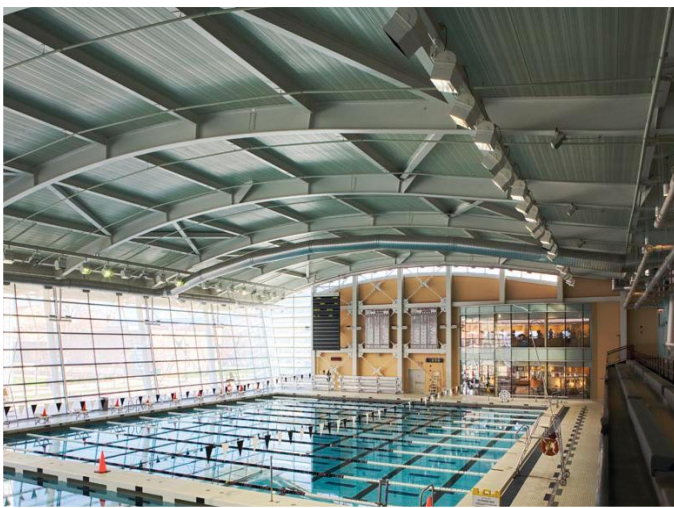

Chicago Metal created **16 reverse curves** of **W33x169#** beams, cold bent on the x-x axis, each without a \$1,500 weld splice. A total of 310 tons of curved beams form the way roof of the Ratner Athletic Center at the University of Chicago, winner of the AISC Engineering Award of Excellence.

Call us at 866-940-5739

Contact us about cost-saving suggestions on *your* next project requiring curved structural steel.



CHICAGO METAL
ROLLED PRODUCTS COMPANY

CHICAGO • KANSAS CITY
cmrp.com





1 Angle Leg Out We bend ALL sizes up to:
 10" x 10" x 1" Angle

2 Angle Leg In
 10" x 10" x 1" Angle

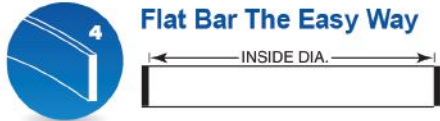
3 Flat Bar The Hard Way
 24" x 12" Flat

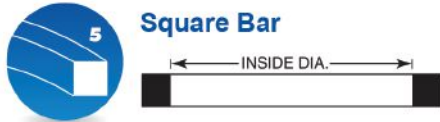
4 Flat Bar The Easy Way
 36" x 12" Flat

5 Square Bar
 18" Square

6 Beam The Easy Way (Y-Y Axis)
 44" x 335#,
36" x 925#

7 Beam The Hard Way (X-X Axis)
 44" x 285#

8 Channel Flanges In
 All Sizes

9 Channel Flanges Out
 All Sizes

10 Channel The Hard Way (X-X Axis)
 All Sizes

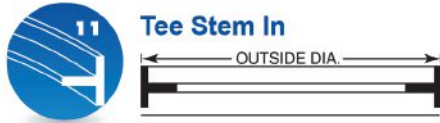
11 Tee Stem In
 22" x 142¹/₂# Tee

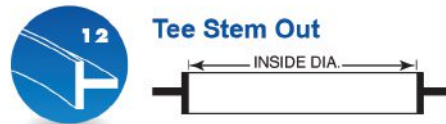
12 Tee Stem Out We bend ALL sizes up to:
 22" x 142¹/₂# Tee

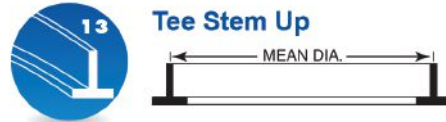
13 Tee Stem Up
 22" x 142¹/₂# Tee

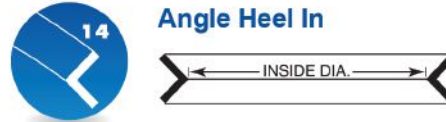
14 Angle Heel In
 8" x 8" x 1" Angle

15 Angle Heel Out
 8" x 8" x 1" Angle

16 Angle Heel Up
 8" x 8"x1" Angle

17 Square Tube
 24" x 1¹/₂" Tube

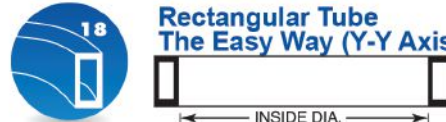
18 Rectangular Tube The Easy Way (Y-Y Axis)
 20" x 12" x 5/8" Tube

19 Rectangular Tube The Hard Way (X-X Axis)
 20" x 12" x 5/8" Tube

20 Square Tube Diagonally
 12" x 5/8" Square Tube

21 Round Tube & Pipe
 24" Sched. 80 Pipe

22 Round Bar
 All Mill Produced Sizes

We also roll stair stringers, helical hand rails, off-axis bends, formed shapes and extrusions.

Visit cmrp.com for more information.



CHICAGO METAL
ROLLED PRODUCTS COMPANY

CHICAGO • KANSAS CITY



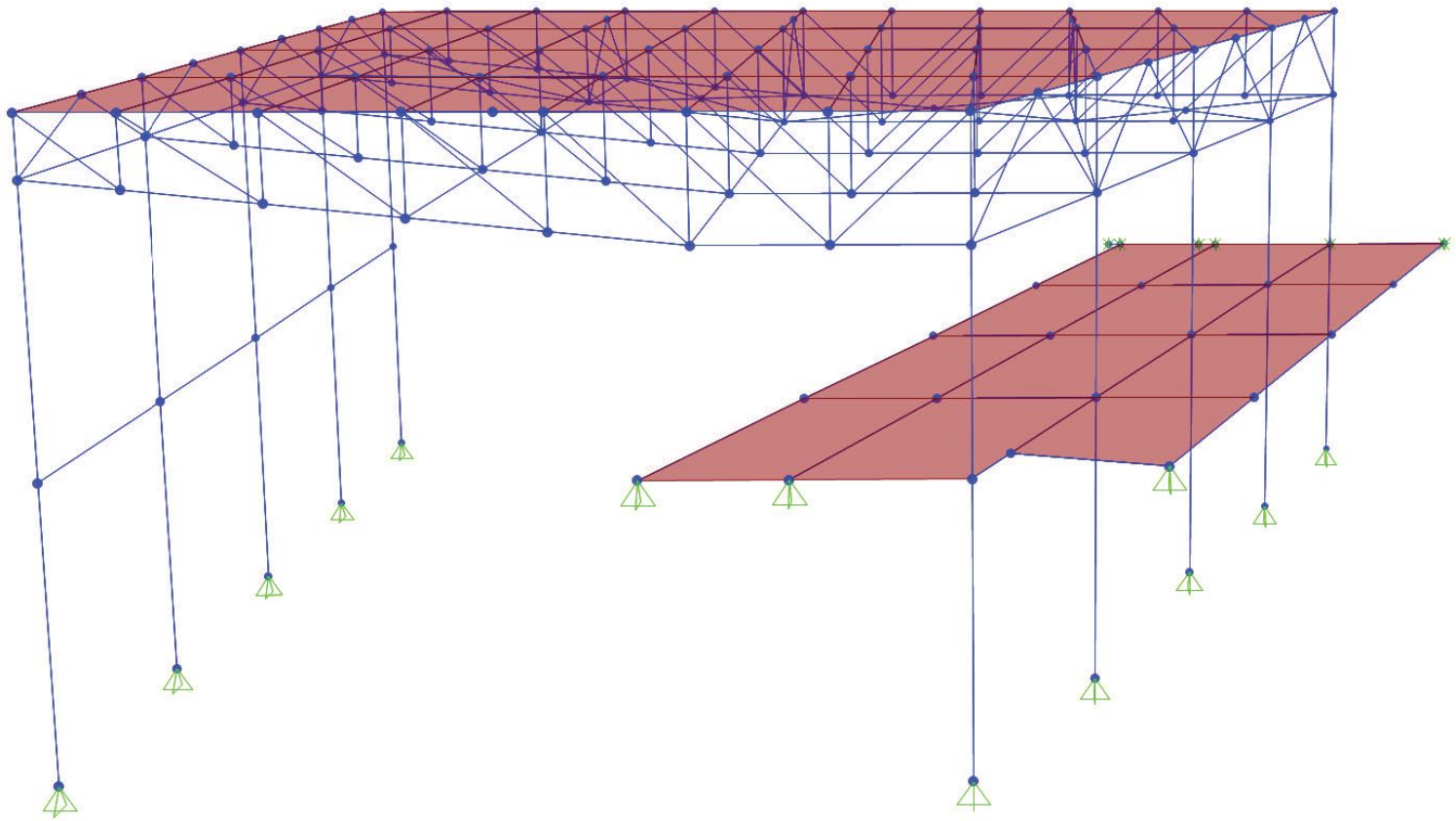

The finite element model used to analyze the second-floor balcony and roof trusses for vibration.

Truss Design and Vibration Considerations

The design of the steel roof trusses incorporated a sloping bottom chord to maintain the sightlines at the top of the video screen. While the lengths of these five roof trusses varied from 40 to 70 ft due to the triangular site, the kink point of each bottom chord remained fixed 30 ft from the truss' south end to preserve these views. The video screen was hung either directly from these trusses or from wide flange framing spanning between the trusses. These locations, along with the bracing of the truss bottom chords, were coordinated with the video screen manufacturer and architectural team.

Since the trusses are part of the lateral system, the bottom chords experience compression, and bracing the bottom chord was a critical component of the truss design. Double-angle shapes comprise the chord and web members of the trusses, and the connections are bolted to be consistent with the existing trusses throughout the ballpark. Like the second floor, the roof trusses cantilever towards the ballpark at their north end to allow the setback of the foundations.

The connection design of the various bracing, moment, hanging, truss, and shear connections was completed by Thornton Tomasetti's Kansas City, Mo., office, which made for seamless coordination between the structural design team in Chicago and the connection design team in Kansas City.

Two areas of the steel structure were particularly sensitive to vibration: the cantilevered balcony on the second floor and the roof trusses above supporting the occupiable roof deck.

Vibration of both areas was evaluated with a finite element model created using the recommendations in AISC Design Guide 11: *Vibrations of Steel-Framed Structural Systems due to Human Activity*. Since the roof trusses and the columns supporting the cantilevered second-floor balcony were part of the typical moment frame on each column line, these two areas were included together in the FEM model.

The steel framing was modeled as frame elements, and the floor slab was incorporated using area elements. Including the slab in the model allowed for realistic mass and mode shapes to be considered and accounted for the composite action between the steel framing and composite slab.

The composite action was quantified by calculating property modifiers that were applied to the frame elements in the model. The property modifiers were determined for strong axis bending using the ratio of transformed stiffness to bare beam stiffness. The transformed stiffness considered the fully composite section moment of inertia, because it's reasonable to assume the full composite action can be developed under small vibration loads. Property modifiers were also applied to the area elements to account for the one-way span behavior of the composite slab.

After properly configuring the model, a modal analysis evaluated the second-floor balcony, and a steady-state function was defined to analyze the roof trusses. Since the balcony is an indoor seating space, its framing was designed for walking excitation and is classified as a restaurant and public space with seating, which limits RMS acceleration to 0.70% of gravity.

Construction of the second-floor balcony and roof trusses at the building's east end.



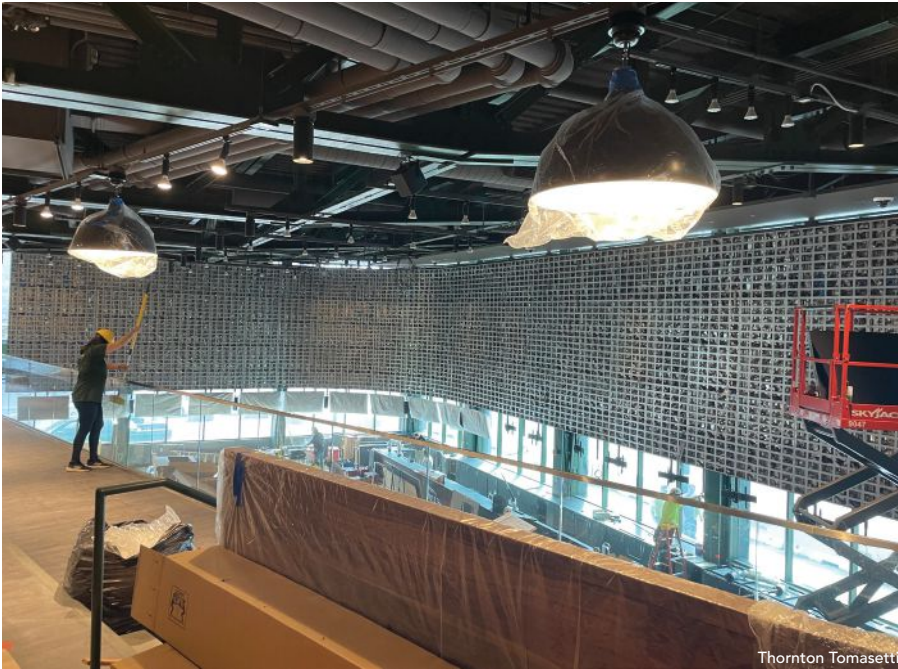

Thornton Tomasetti

above: The video screen backup panels.

below: The two-story space with the wraparound video screen and seating.



Marquee Development and DraftKings



Joe Porada (jporada@thorntomasetti.com) is a project engineer, **Kevin Jackson** (kjackson@thorntomasetti.com) is an associate principal, and **Chris Porst** (cporst@thorntomasetti.com) is a senior project engineer, all with Thornton Tomasetti.

On the other hand, the roof trusses are subject to rhythmic excitation because they support outdoor space filled with excited baseball fans. Thus, the design activity was classified as a lively concert or sporting event space, which has a higher corresponding RMS acceleration limit of 3.5% of gravity. The balcony framing and roof trusses met those criteria.

Using structural steel to overcome the site's geometric constraints while achieving long, cantilevered spans with limited deflection and vibration helped the Cubs complete a unique addition to the Wrigley Field campus that complements the renovations made over the last decade. By way of several intentional design decisions, the DraftKings Sportsbook has been incorporated into Wrigleyville's fabric while maintaining the ballpark's historic appeal and aesthetic. ■

Owner

Wrigley Field Holdings, LLC

General Contractor

Pepper Construction

Architect

Gensler

Structural and Connection Engineer

Thornton Tomasetti

Fabricator and Detailer

LeJeune Steel 



Rapid Response

BY BRENDA CRUDELE, PE, JULIANNE FUDA, PE, AND
RONNIE MEDLOCK, PE

The steel industry's emergency repair skills ensured a replacement for a flood-damaged upstate New York bridge opened within mere months.

AN EVENING STORM gripped the Town of Long Lake, N.Y., on July 10, 2023, and left damaged infrastructure in its wake.

Floods, washed-out roads, and damaged bridges and dams are major inconveniences for any municipality. They're crushing for a remote town of about 400 in the Adirondack Mountains. Each roadway into the community is essential, and substantial road or bridge damage can usher in 80-mile detours.

The next morning, New York State Department of Transportation (NYSDOT) inspectors surveyed bridges and culverts in the flooded area—including the State Route 28N bridge over Fishing Brook.

The bridge inspection—accessed by way of a side-by-side utility vehicle due to flooding and damage on the surrounding roadways—revealed that a dam breach just upstream of the Route 28N crossing undermined the west abutment of the bridge and created 12 in. of settlement, which damaged the

superstructure, deck, and abutment. The existing bridge was built in 1932 and founded on spread footings on dense soil. Inspection results and a review of the record plans concluded that the existing bridge could not be rehabilitated and needed to be replaced.

Bridge replacement projects can typically last more than a year. This one, though, needed to be completed faster. State Route 28N is too crucial a roadway to have a temporary replacement bridge for much longer than a few months, and construction had to be done before the Adirondack winter set in, which can happen as early as October or November.

NYSDOT's readiness and collaboration, combined with High Steel Structures' efforts, led to completion in just four months.

NYSDOT's Structures Design Bureau has a robust in-house design staff with experienced design engineers and drafting technicians trained to respond to emergencies. The State Route



The State Route 28N bridge over Fishing Brook in upstate New York is a primary roadway for the small Town of Long Lake.

All photos courtesy of NYSDOT

28N bridge emergency replacement was quickly assigned to an in-house design squad, and work commenced immediately.

Work to reopen the roadway with a temporary bridge also began right away. An 80-mile detour was untenable, especially during the summer tourist season that drives the local economy.

NYSDOT and the contractor decided that a temporary Acrow bridge could be installed to span over the damaged existing bridge. Ultimately, a temporary roadway alignment needed to be built north of the existing bridge to allow for construction of a replacement. However, the temporary roadway would require importing significant amounts of clearing and fill to a remote area, adding considerably more time.

The solution for a short-term reopening was installing an Acrow truss to span over the existing bridge as an initial temporary roadway. Phase one of the project included assembly of the temporary Acrow truss and construction of temporary foundations

and approach roadway work to build up the embankment that took the truss up and over the existing bridge. The temporary bridge opened to traffic on July 28, just 18 days after the flood event.

While the design and fabrication of the new bridge continued, Phase two of the emergency response commenced in the field. When State Route 28N reopened, the contractor focused on constructing a temporary roadway alignment north of the existing bridge. The highway design criteria determined the temporary offline alignment's location, but the contractor also suggested that the offset to the temporary alignment from the existing bridge leave enough room to stage two cranes. That way, the contractor could erect both cranes and leave them in place for the duration of construction.

The cranes were used to erect the temporary bridge on top of the damaged bridge, move the temporary bridge to the temporary alignment, erect the steel beams for the new bridge and

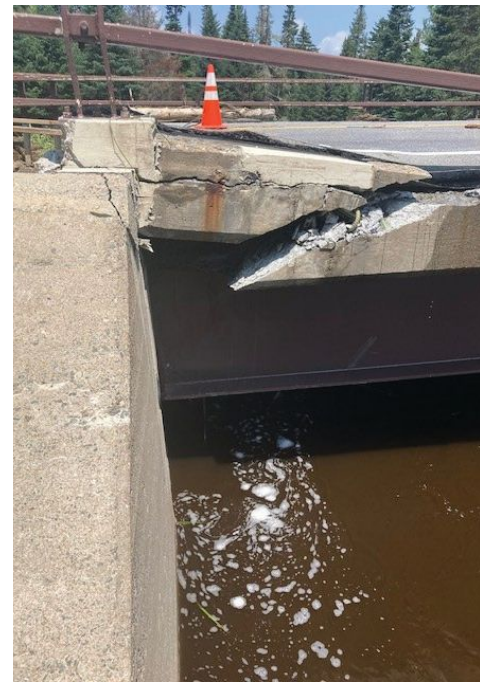

A close-up look at the damage a July 2023 flood inflicted on the State Route 28N bridge over Fishing Brook.

.....

disassemble the temporary bridge. Having one crane staging area for the duration of construction saved considerable time and reduced the impact on travelers during the temporary bridge relocation.

Once the land was cleared, fill and stone protection was placed around the temporary foundations. State Route 28N was shut down the morning of August 17 to relocate the temporary Acrow bridge. Construction crews moved the temporary bridge, paved the approach roadway and reopened Route 28N that evening. At that point, demolition of the existing damaged bridge and construction of the new bridge could begin.

Phase three—design and construction of the new bridge—began soon after the initial closure. With the ticking clock in mind, the NYSDOT engineering team considered several structures that could be constructed and open to traffic before winter.

During the preliminary structural layout phase—in coordination with the hydraulic requirements and geotechnical considerations—NYSDOT engineers suggested repurposing existing steel rolled beam sections that NYSDOT owned and were stored at its Oneida East Residency, 203 miles from the State Route 28N bridge location.

The original intended use of these rolled beams was for the deployment of a temporary bridge utilizing steel beams with heavy-duty

metal grate deck panels. The metal grate deck panels did not perform well during NYSDOT's last deployment in summer 2021, so the beams were not scheduled for future deployment. Except for the metal grate deck panels, the 12 100-ft W36x160 beams were still in good condition and saved for future use.

NYSDOT designers determined that an 80-ft hydraulic opening would meet the bridge's hydraulic needs and the 100-ft-long beams could be cut to approximately 81 ft to accommodate NYSDOT's required 1.2 LRFR minimum load rating factor.

Additional beam length was maintained to utilize integral abutments, creating a jointless structure for increased service life and decreasing construction time by reducing the number of piles and eliminating a separate concrete pour for the footings. The beams were modified with shear studs to be composite with the concrete deck and given a coated paint system for protection.

right: A temporary Acrow bridge was initially placed over the damaged bridge.

below: The Acrow bridge later moved next to the damaged bridge during construction.





above: Steel H-piles being installed at new abutment locations.



left: Epoxy coated steel reinforcement at the new integral abutment.

.....

NYSDOT knew the expedited bridge design would take only a couple weeks, but rapid steel procurement was of utmost concern. NYSDOT met with High Steel Structures July 25—15 days after the storm—to verify that accelerated fabrication was feasible and determine if High Steel could meet a September 1 fabrication deadline that ensured the bridge would be built and the concrete deck would be poured before winter arrived.

NYSDOT shared design drawings for the repurposed rolled beams and discussed the project’s specific details, such as the diaphragms, with High Steel. The original rolled beam deployment included steel diaphragms that were installed level to be used with the flat metal grate deck panels. However, in the proposed Route 28N configuration, the rolled beams supported a concrete deck with a cross slope.

Ideally, the diaphragms would be placed on a slope to accommodate the cross-slope of the deck. Using the existing diaphragms meant the deck had to be poured with variable haunches to maintain the proposed roadway profile. NYSDOT engineers were hesitant because of the additional delay risk, but High Steel confirmed it could fabricate new sloped diaphragms and deliver the repurposed beams by September 1.

High Steel also contributed several value-added suggestions, including delivering beams in pairs with pre-installed

High Steel Structures delivered fabricated girders by September 1.

.....

diaphragms to cut shipping costs and erection time. High Steel Structures picked up the beams from Oneida East Residency July 27 and shipped them to its Lancaster, Pa., fabrication facility.

High Steel submitted shop drawings on August 1. NYSDOT and High Steel Structures staff had a conference call on the same day to discuss comments and review the final design plans. The shop drawings were revised and approved one day later. The quick turnaround was largely due to early coordination between NYSDOT and High Steel at the onset of the emergency response.

Fast Fabrication

NYSDOT called High Steel to discuss expediting a fabricated steel bridge. When factoring in shop drawings and their approval process, fabricating a bridge like the new State Route 28N with typical beams (either plate girders or W-shape beams) and framing usually takes nine months to a year. The actual fabrication work on the shop floor, though, takes about two weeks.

High Steel knew it could support the aggressive schedule with close cooperation and teamwork and provided fabricated steel within two months. There were six keys to rapid delivery:

- **Weekly Meetings** – High Steel and NYSDOT met weekly in the early stages to facilitate discussion of optimal design details, material use and shop drawing development.
- **Expeditious Designs** – NYSDOT provided High Steel with complete designs the day after it notified High Steel of the project.
- **Shop Drawing Approval** – High Steel took only one week to provide shop drawings to NYSDOT, which NYSDOT approved in one day. High Steel was approved to start working in the shop within one week of NYSDOT's call. That process included a meeting between High Steel and NYSDOT where drawing comments were presented, discussed, addressed, and approved.
- **Material Procurement** – NYSDOT taking available beams from a previous bridge expedited material procurement, and High Steel only had to cut them to the desired length.



Pre-engineered In-Field Adjustable

Structural
Support Frames
that Remove
Coordination
Hassels

Find Out More
by Getting a Quote

quickframes.com

QUICKFRAMES™



above: Stay-in-place steel deck forms were installed on the new bridge.

below: The new bridge opened to traffic on October 27.



It's a testament to steel's versatility: unused beams can readily be cut to any length needed and repurposed. Beams were shipped in pairs, helping expedite and save costs in delivery.

- **Welding Procedure Approval** – Welding procedures were reviewed and approved within one week of submittal.
- **Painting** – The beams were painted in their previous use, but the paint needed to be removed for welding and other fabrication steps before it was re-painted the same color. Local blasting and touch-up were considered, but shot-blasting off all existing paint and re-painting the girders was determined to be faster.

When questions arose, the two parties immediately discussed them by phone or conference call. NYS DOT provided verbal answers that High Steel could consider official—keeping High Steel moving with fabrication while formal documentation followed later. The trust between NYS DOT and High Steel was the most important factor in accomplishing the tightened fabrication schedule.

Construction

NYS DOT completed final bridge design and plan preparation in 22 days. Design staff prepared regular progress plan sets for all stakeholders, including the contractor, NYS DOT management, hydraulic engineers, geotechnical engineers, highway designers, and environmental staff. Those plan sets allowed the contractor to procure materials, such as pile sizes for the foundations and reinforcing bars for the abutments, while the contract documents were being finalized. Coordinating with the contractor during the design phase was crucial to ensuring everything specified in the plans was constructible in the short time frame.

The contractor contributed several value-added suggestions as well, namely the foundation installation. The boulders in the Adirondacks create difficult driving conditions for H-piles, but a drilled foundation can significantly increase construction duration. Since the bridge crosses a waterway, a minimum pile length is required to harden the bridge against future scour.

The contractor proposed a combination of a drilled and driven foundation solution that saved valuable construction time in the field while still meeting the project's geotechnical design requirements. Using integral abutments with attached wingwalls also reduced the number of piles needed to support the bridge, thereby reducing the construction duration.

The contractor also elected to pour the integral abutment backwalls concurrently with the concrete deck, eliminating the need for a separate backwall pour.

The contractor worked six or seven days a week for the entire summer and fall, completing the new bridge on October 27, just four days before the area's first snowfall.

The new bridge opened to traffic at 6:30 p.m. October 27 with a line of residents waiting to be the first to cross the bridge. Seeing the positive impact on the community after the devastating floods made the long hours in design, fabrication, and construction worthwhile. ■

Owner

NYSDOT

Bridge Designer

NYSDOT Office of Structures

Highway Designer

NYSDOT Region 2

Contractors

Tioga Construction (temporary bridge work)

Cold Spring Construction (permanent bridge work)

Steel Team

Fabricator and Detailer

High Steel Structures, LLC 

Temporary Bridge Fabricator

Acrow 



Brenda Crudele (Brenda.Crudele@dot.ny.gov)

is the Director of the Structures Construction and Fabrication Bureau within the Office of Structures, and **Julianne Fuda (Julianne.Fuda@dot.ny.gov)** is the



Director of the Structures Design Bureau within the Office of Structures, both with the New York State Department of Transportation. **Ronnie Medlock (RMedlock@high.net)** is the Vice



President of Technical Services for High Steel Structures, LLC.

For the fabricator looking to maximize their production time and profits, the Lightning Rail is a smart decision.

Eliminate the countless manual labor hours involved in laying out handrails, stair stringers, trusses, and more!

- ✓ Cut fabrication time by more than 50%
- ✓ Ensure the highest level of accuracy
- ✓ Boost your profit margins
- ✓ Lay out complex geometry in seconds
- ✓ Designed to replace your existing fabrication table

"The guys love it. They jumped right in on it and have been working to make the most use of it. Great purchase."

Nat Killpatrick
Basden Steel Corporation

"I think it's fair to say that this machine continues to exceed our expectations. We are very happy with it."

Chief Operating Officer
Koenig Iron Works



by Automated Layout Technology™

Patent No. US 10,576,588 B2
Patent No. US 11,426,826 B2

SPEED, ACCURACY, & HIGHER PROFIT MARGINS

603-402-3055
AutomatedLayout.com



Artistic Connections

BY KAITLYN M. PALMER, SE, PE, NATHAN C. ROY, PE,
KEVIN BERGERON, AIA, AND MICHAEL PRATTICO, AIA

An innovative fine arts building used steel
to achieve its desired open layout
and undulating glass façade,
helping make it a campus
centerpiece.



ROCHESTER INSTITUTE OF TECHNOLOGY (RIT), one of the top universities in the nation focusing on the intersection of technology, arts, and design, recently completed its largest construction project since opening its current campus location in the 1960s.

It's a shed—in proper name only.

The Student Hall for Exploration and Development (SHED), opened in fall 2023, is a creative hub that brings the arts to the center of campus. Its features include a flexible event theater, studios for dance and music, and large active classrooms and makerspaces that foster collaboration and learning. It's prominently located on the campus's "Quarter Mile" walkway, which connects the academic and residential sides of campus.

Beyond serving as the creative hub, the SHED provides a missing link by connecting Wallace Library with Monroe Hall and the Campus Center student union. All told, the SHED has a 1,900-ton steel frame. Design architect William Rawn Associates collaborated on the design with architect of record HBT Architects and structural engineer LeMessurier.

RIT History

Founded in 1829, RIT originally built its campus in downtown Rochester, N.Y. However, in 1959, the planned Interstate 490 extension prompted RIT to weigh staying downtown or relocating entirely and creating a new campus. RIT had goals to grow and establish itself as a leader in technical education, and with those in mind, it decided to move six miles from Rochester and create a new home in nearby suburb Henrietta.

RIT's directive for the campus design noted that "academic buildings will be rugged but simple. The range of materials, construction techniques, and finishes must necessarily be limited, and beauty must come through quality of space and proportion and a sense of ordered form." The school called on five modernist architect firms to collaborate on the design of the new campus: Hugh Stubbins and Associates, Kevin Roche John Dinkeloo and Associates, Harry Weese Associates, Edward Larrabee Barnes Associates and Anderson, Beckwith and Haible.

Each firm was responsible for a portion of the campus, with LeMessurier as the structural engineer for all the projects. The Henrietta campus included 13 academic buildings that totaled more than 1 million sq. ft and a new residential dorm complex. Buildings were clad in brick with a heavy massing in the Brutalist form of architecture. The SHED, characterized by an undulating glass façade, large open spaces, and exposed structural steel framing, embodies the initial vision for the Henrietta campus that buildings should be "rugged but simple," and emphasize "space and proportion and a sense of ordered form."

.....
The SHED is a creative hub that brings the arts to the center of campus.

© Robert Benson Photography

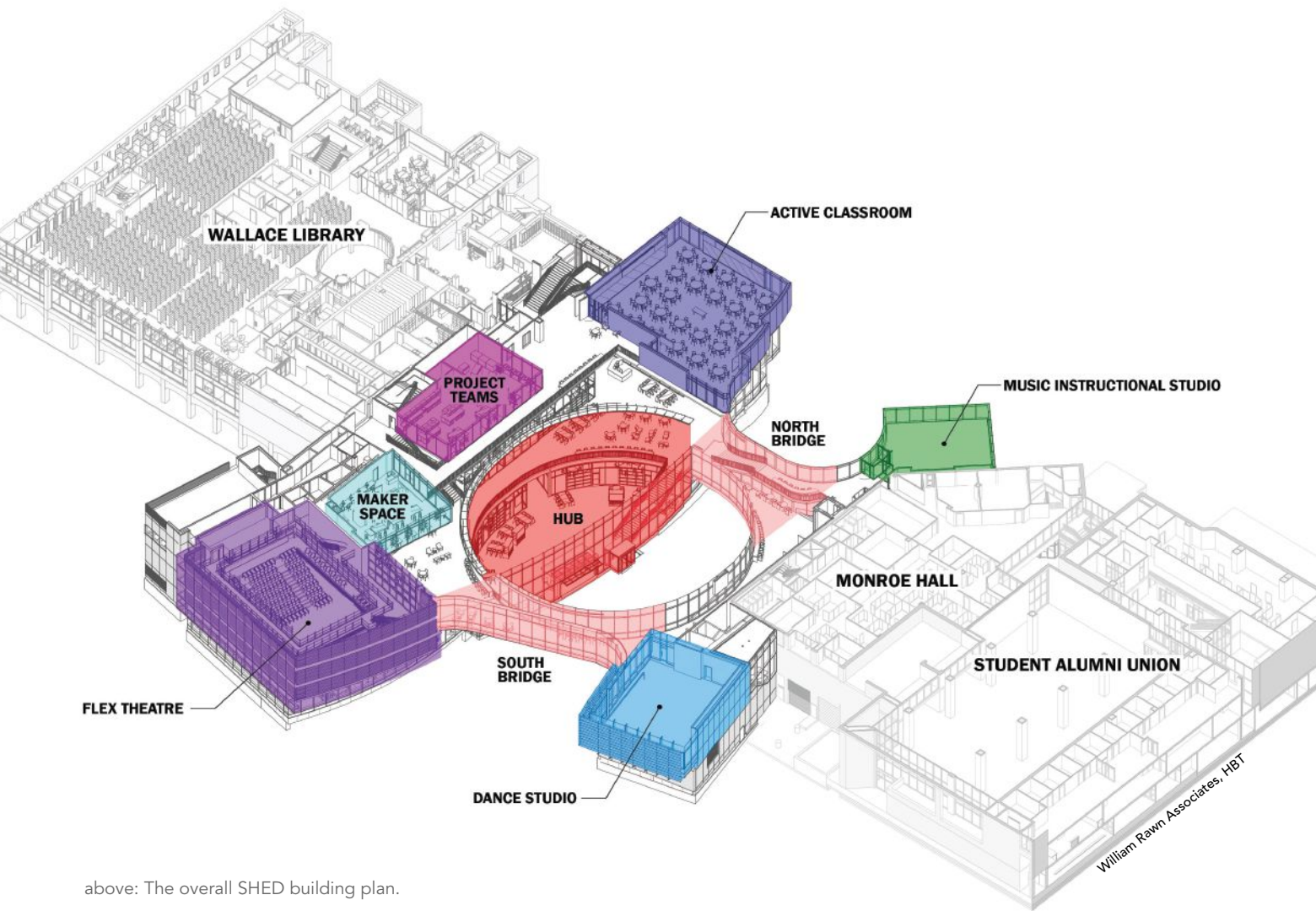

above: The overall SHED building plan.

below: An isometric of the SHED's steel framing.

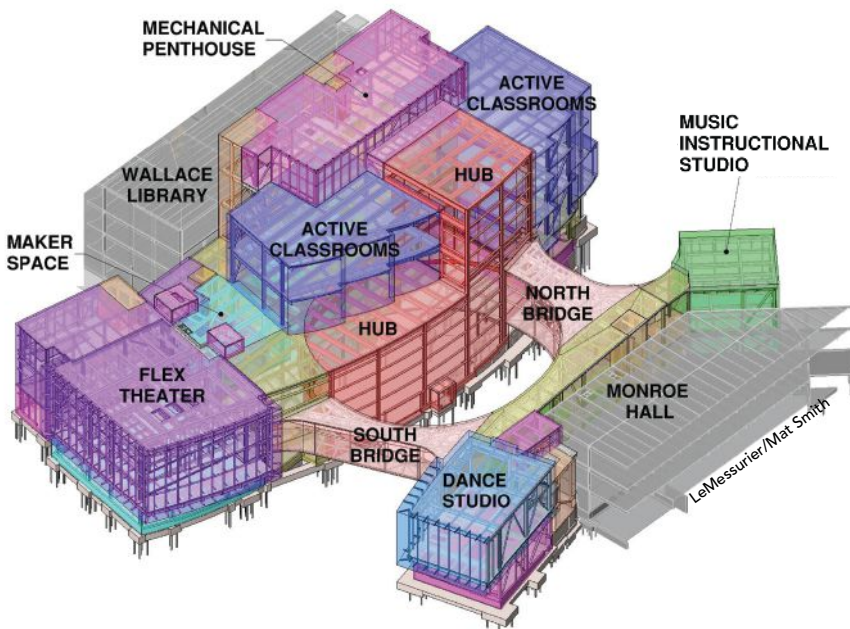

SHED Layout

The SHED is comprised of the West Wing adjacent to Wallace Library and the East Wing adjacent to Monroe Hall, and those wings are connected by two bridges that complete a circular heart of the building. Each department has a unique portion of the building, and those portions are linked by interconnecting corridors that foster collaboration. Makerspaces and active classrooms are located around the central area called the “Hub” in the six-story West Wing, promoting creativity and exploration.

The flexible event theater, located at the south end of the West Wing, also abuts the Hub and is prominently featured with a large cantilevered east edge and a double skin façade. The music studio is nestled into the northeast corner of the building, maximizing natural sound isolation. Projecting out on the southeast corner is the dance studio with an elegant sunshade structure on the exterior of the façade.

Throughout the complex, open workspaces and meeting nooks create a comfortable and collaborative environment. Glass façades showcase the innovative and collective creative activity energizing the building.

The SHED links the Wallace Library with the Student Alumni Union.



The Hub

The West Wing's focal point is the Hub, a five-story atrium that is also part of the "circular heart" design with a large glass façade providing transparency to the community. The Hub is ringed with a circulation path at the first floor from the West Wing that carries through the north bridge, the East Wing, and completes the circle at the south bridge. Layered on the circulation ring is a second ring that forms the bridges' soffits and the East Wing, creating a suspended rigging platform within the West Wing. Active classrooms, project team areas, makerspaces, and performance venues surround the Hub.

The active classrooms, ranging from 60 ft by 60 ft to 60 ft by 70 ft, are column-free areas arranged in a stacked and staggered configuration throughout the building's West Wing. W33 to W36 beams and W40 to PG48 (48-in. built-up plate girders) support larger spans while minimizing vibrations from walking. A focal point from the Quarter Mile approach is the active classroom cantilevering over the pathway. The 10-in.-deep second-floor framing hangs from deeper members at Level 3, creating a 15-ft overhang with a razor-thin soffit. A generous floor-to-floor height of 20 ft aligns with the scale of the spaces and accommodates the steel framing depths at Level 3.

The industrial aesthetic and functionality of the active teaching and makerspaces are emphasized through exposed steel framing, decking, and MEP systems. The design team collaborated closely with acoustical consultant Threshold Acoustics to

incorporate built-up floor assemblies and hung acoustic barrier ceilings that address noise control. Active classrooms typically utilize floating wood floors with pre-spaced isolators and roll-out batting, while makerspaces feature concrete topping slabs with a ¾-in. resilient mat.

Serving the Arts

A 300-seat, 4,700-sq. ft, 70-ft-tall flexible theater with a double-skin glass façade projects outward from the south end of the West Wing. Flexibility is paramount to the design and allows the glass-box theater to transform to a black-box theater with black-out shades integrated into the façade. Two levels of balconies hang from the roof and use a thin structure to maximize headroom. A tension wire grid and rigging steel are also hung from the roof steel to provide full flexibility for theater performances.

Telescoping seating is designed and stored at the back of the theater to provide additional seating for performances. An expansion joint between the main West Wing and the theater isolates sound transmission. A topping slab and resilient flooring system below the wood floor minimizes sound transmission from the makerspace directly below the theater.

The flexible theater is enclosed with a double-skin glass curtainwall, allowing airflow within the cavity to improve thermal efficiency and mitigate sound transmission between the interior and exterior. Architecturally exposed hollow structural section (HSS) framing supports the double-skin curtainwall system and extends

RIT began building its Henrietta campus in the late 1960s.

.....

vertically for 36 ft from the theater floor to the roof. Outriggers from the vertical HSS support a grating system that allows access to the double-skin cavity at five levels. HSS members are carefully aligned to the glass joints, maintaining a seamless appearance.

The end connections of the HSS verticals were designed with fixed moment connections at both ends to minimize member size while adhering to stringent deflection criteria for the façade. The HSS members are supported at their bases for gravity loads and utilize vertical slip connections with moment fixity at their tops to permit vertical movement of the long-span roof framing. The construction documents outline a planned installation sequence for the HSS façade support framing, scheduled after steel erection and slab placement. This sequencing ensured stringent installation tolerances on the steel to meet the specified critical façade requirements.

The Music Instructional Studio, situated to the northeast, completes the north bridge's exterior curve. Like the active classrooms in the West Wing, hangers allow a thin cantilevered soffit that creates a warm welcoming space for the café below. Resilient flooring isolates noise transmission between the two spaces, and a double-height music studio space allows for enchanting musical performances with expansive views of the Quarter Mile.

The dance studio at the southeast corner projects from the central form and is linked to the West Wing by the southern bridge and the music studio by the East Wing. It has W30 beams at the floor and roof to cantilever out, creating a column-free space below and column-free interior space for unobstructed views. A finite element analysis was used to design the dance studio for rhythmic excitation from dance and aerobics. Forcing functions were applied to evaluate the acceleration of the structure under rhythmic excitation, tuning the structure to ensure the comfort of the occupants of the dance studio.

From the cantilevered structural form of the dance studio projects a cantilevered, tensioned sunshade structure with a shaped WT at the base and top and pre-tensioned cables supporting individual blades. Vertical HSS posts with fixed moment connections were provided behind each tension cable to support the tension sunshade and glass façade while meeting deflection requirements.

.....

The Hub under construction.

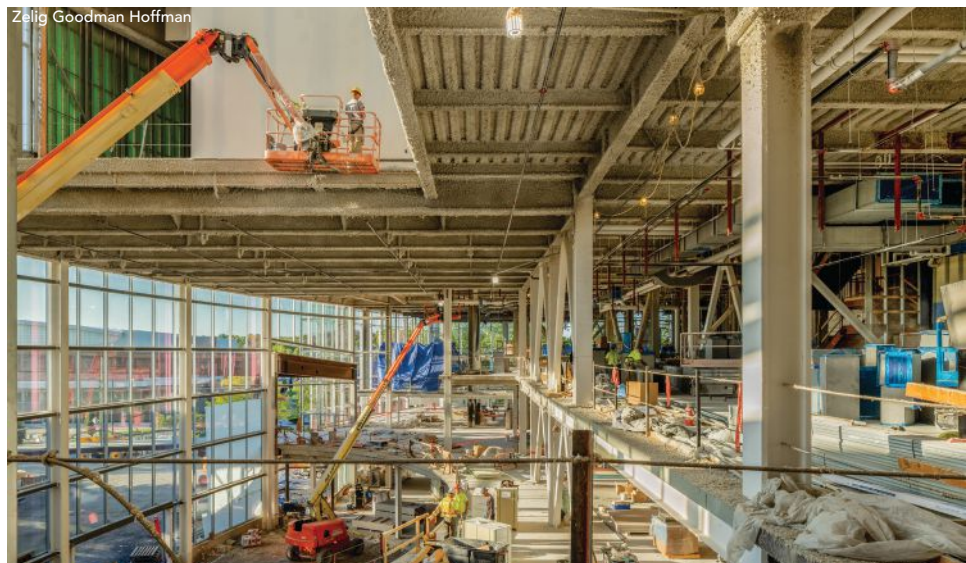



above: The SHED south bridge under construction.

below: The Hub with both bridges and the East Wing in view.





above: Two W36 girders are the primary structural system for the north and south bridges.

below: The double-story north bridge is 67 ft long.

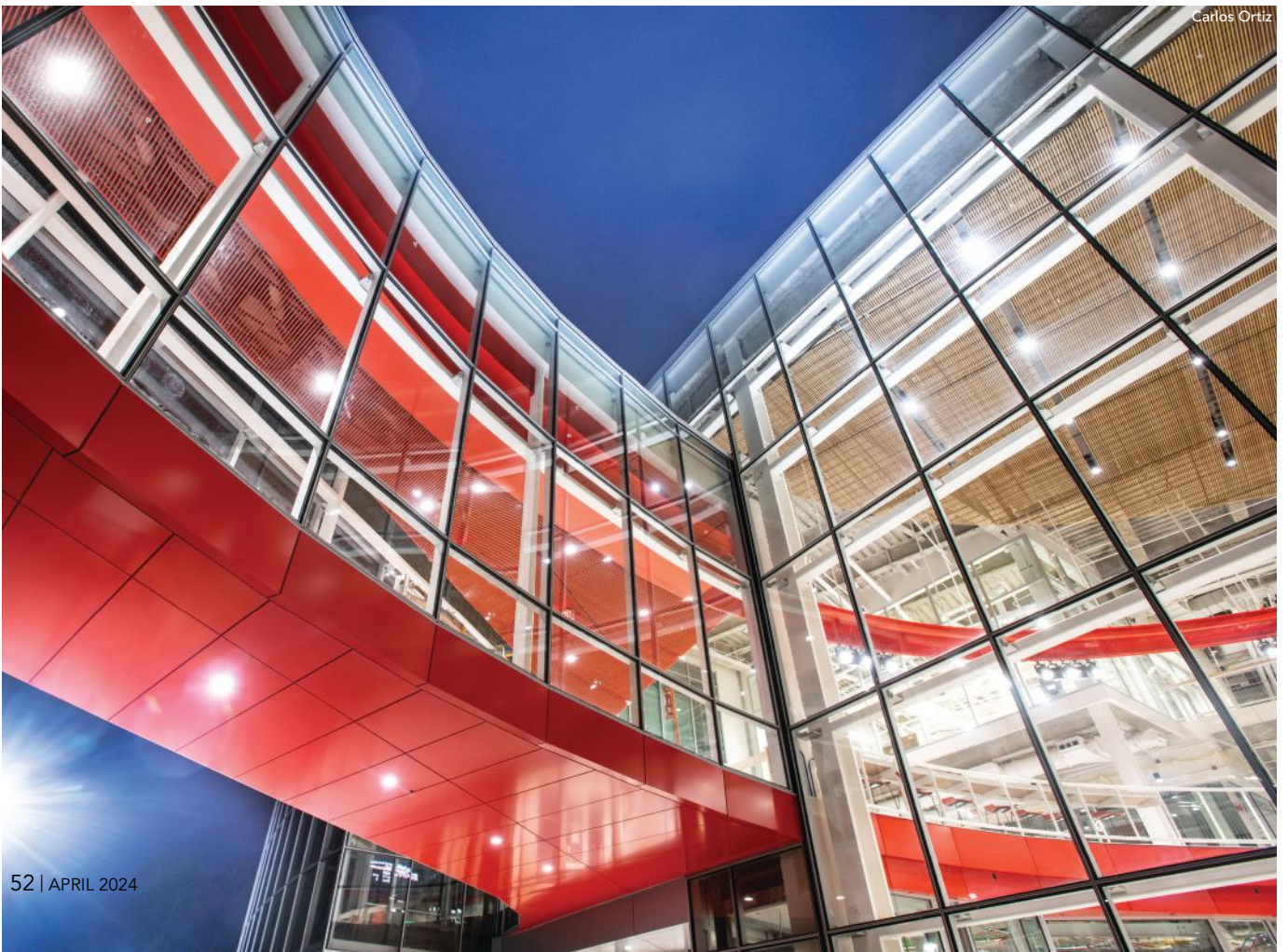

Providing Connection

Establishing a connection between the East and West wings was crucial to the project. The north and south glass-enclosed bridges shape the SHED's central heart and provide the connection. The south bridge, a single-story structure, is 88 ft long and 9 ft wide at its narrowest and links both wings' second floors. Meanwhile, the double-story north bridge is 67 ft long and 19 ft wide at its narrowest. The north bridge connects the West Wing's second floor to the East Wing's second and third floors.

Several constraints influenced the design of the bridges: ensuring a minimum clear height below the bridge to accommodate fire truck access, incorporating a flared bridge in plan that narrows at mid-span and widens at the ends, and integrating a continuous sloped roof descending from north to south. The roof at Level 4 in the north bridge transitions through the East Wing and resumes at Level 3 in the south bridge.

The primary structural system for both bridges consists of a pair of W36 girders spanning down the center at the roof level. Due to the flared plan shape, the girders were set at the narrowest point of the bridge. Sloped, cantilevered roof purlins of varying lengths were stacked perpendicular to the W36 girders. The sloped roof purlins support architecturally exposed HSS hangers on each side of the bridge.

The hangers support the lower floors and the wind girts, minimizing the required curtain wall mullions depth. Hanging the floor structure from the roof allowed minimal depth for the floor structure to meet the required clear height for access. The framing at the bridge floor utilizes W10 members with steel deck inset between, aligning the top of the composite deck with the top of the beam. A further floor framing complication at the north bridge was the connection to multiple floor levels on each side of the bridge, which required built-up 10-in. members to be kinked because interior hangers did not provide the desired openness of the design.

In-plane steel trusses at the floor and roof levels act as the diaphragm. An expansion joint is located at each bridge's west end and is laterally supported with a steel moment frame, while the east ends are connected and laterally supported by the East Wing.

Finding a Name

To foster student ownership of the new building, RIT leadership held a competition to name the complex. Jonathan Dharmadi, a fourth-year student with a focus in new media design, won the student competition and christened the building the Student Hall for Exploration and Development.

The SHED name captures the true essence of the building and its role as a focal point for the RIT community. The building serves as the nexus for linking arts with technology, fostering connections, and offering dedicated spaces for learning and exploration—with the goal of nurturing the development of future leaders. ■

Owner

Rochester Institute of Technology

Design Architect

William Rawn Associates

Architect of Record

HBT Architects (part of MRB Group)

Structural Engineer

LeMessurier

Construction Manager

Welliver

Steel Team

Fabricator

Kinsley Steel, Inc. 

Steel Detailer

International Design Services, Inc. 

Bender-Roller

Greiner Industries, Inc. 



Kaitlyn M. Palmer

(kpalmer@lemessurier.com)

and Nathan C. Roy

(nroy@lemessurier.com) are

principals with LeMessurier.

Kevin Bergeron

(kbergeron@rawnarch.com) is an

associate principal with William

Rawn Associates. Michael Prattico

(michael.prattico@mrbgroup.com)

is a senior project manager with

MRB Group.

An architect shares his perspective on designing with the SpeedCore structural system.

Architect's Angle

INTERVIEW BY PATRICK ENGEL



Gensler

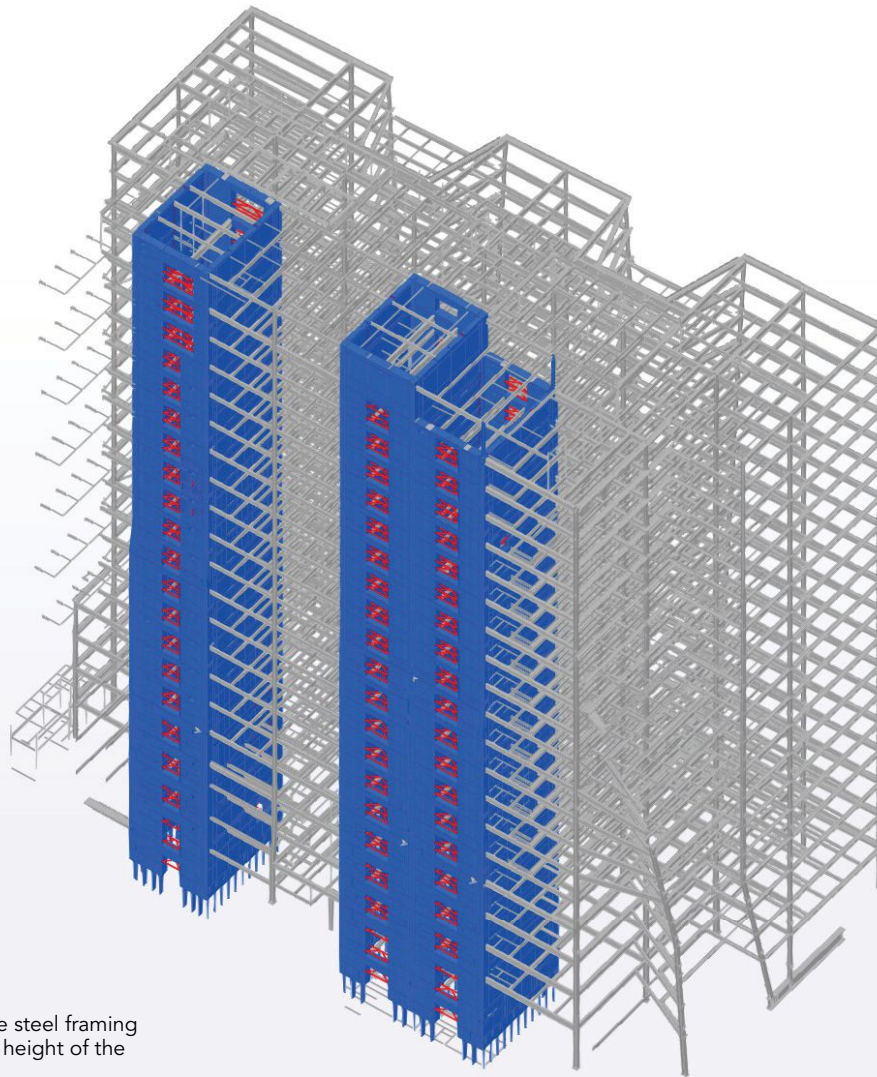

A 3D model of the steel framing (gray) and the full height of the cores (blue).

Schuff Steel

THE SECOND BUILDING designed with SpeedCore is nearing its grand opening.

The office tower at 200 Park Avenue in San Jose, Calif., is a 300-ft, 19-story building—the tallest in the city—that topped out in January 2022, with construction set to finish in the first half of 2024. It has more than 965,000 rentable square feet and will be a notable addition to San Jose’s downtown business district.

The building joins Rainier Square—a 58-story mixed-use skyscraper in Seattle that opened in 2021—as a SpeedCore structure. Also known as composite steel plate shear wall/concrete-filled (C-PSW/CF), SpeedCore is a structural system with prefabricated panels that can be stacked like LEGO bricks to form a traditional core. Those panels are then filled with concrete—10,000-psi grout in 200 Park’s case—to create a stiff and sturdy core. The system can help an erector build four floors a week, compared to one floor every three to five days using more traditional methods.

The project team of Jay Paul Company (owner), Level 10 Construction (general contractor), Gensler (architect), and Magnusson Klemencic Associates (structural engineer) picked SpeedCore because it fit the building, but also because of its success on the Rainier Square project, which MKA also engineered.

Using SpeedCore required the team to collaborate early and often, but its benefits were evident when the building topped out. The system shaved approximately three months off erection time

and helped save approximately 20% on core wall thickness compared to a traditional cast-in-place concrete design.

Chris Payne, a Senior Associate at Gensler, was 200 Park’s Technical Director. He spoke with *Modern Steel Construction* to provide an architect’s perspective on working on a SpeedCore project.

Who chose SpeedCore for the building: you as the architect, the engineer, the steel fabricator, or a collaboration of all three?

It was a collaborative decision-making process among key project stakeholders. Early on, we studied different structural systems, as we do on all projects. Weighing the pros and cons of each approach, we determined the right solution for this project given the unique site constraints, the program, and the client’s ambition.

Our structural engineers at MKA were critical to the decision-making process and offered SpeedCore as one of the viable options. There were several compelling reasons to consider it at the time, leading to its ultimate selection.

What were some of the reasons SpeedCore was selected?

Speed is the obvious first answer, which then equates to cost savings on erection time and construction. Safety was another important consideration because many of the components for SpeedCore are prefabricated in a shop, limiting onsite construction and installation sequences.



The building is prominently located in downtown San Jose.

Schuff Steel

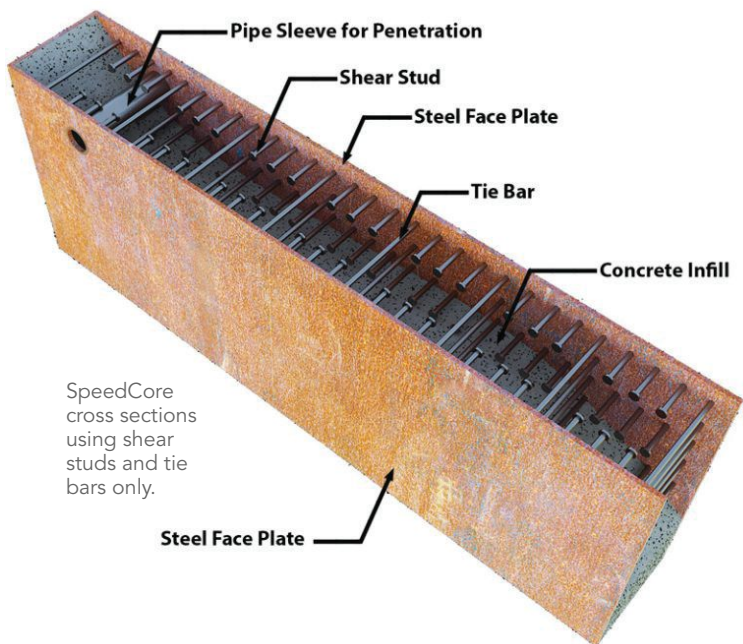

SpeedCore cross sections using shear studs and tie bars only.

When designing with SpeedCore, did you have to consider anything extra during the design that maybe you wouldn't have if it was a typical frame?

First, just knowing that it's an innovative system that doesn't have a lot of precedent. This project is the first in California to use SpeedCore. There was certainly a little more hands-on coordination with the city during the approvals process and understanding the fire resistance ratings and the structural capacities. The city had more questions about SpeedCore's details during the plan-check process.

The other part is the nature of the system. It's essentially permanent steel formwork that gets filled with concrete. It's so much more immovable once it's set. That means more legwork up front to coordinate penetrations through the walls for ductwork or pipes. With SpeedCore, adding those after the building is finished is not easy.

It pushed up our coordination and design schedule. We typically get into the details of coordination with structure in the Construction Documents phase of design. For SpeedCore, we pushed it up to Design Development, which is much earlier than we normally would get to coordination with structure.

How much appeal was there to designing the state’s first Speed-Core building?

Certainly, we wanted the building to be forward-looking and modern. It’s one of the first speculatively designed office buildings built in San Jose in the last decade or so. It’s also the tallest building in the city. By the nature of the project brief, we knew this would be a special building.

I don’t think we shied away from being the first in California, but that did not drive the decision to use SpeedCore.

What makes designing with SpeedCore unique?

The schedule aspect of doing things earlier than normal is the most significant aspect. But the thinner core walls tipped the structural system decision toward SpeedCore. A traditional cast-in-place concrete core has a certain thickness, and we were able to save about 20% of that overall wall thickness by utilizing SpeedCore. Adding leasable square footage was desirable for the whole project team.

What was the goal and the vision of the building’s architecture, and why did SpeedCore fit that?

Because we didn’t have a specific end user in mind, we wanted to create a flexible container that could accommodate many uses with a high-performance interior experience. We knew it would be a workplace, whether for technology, creative, or traditional professional

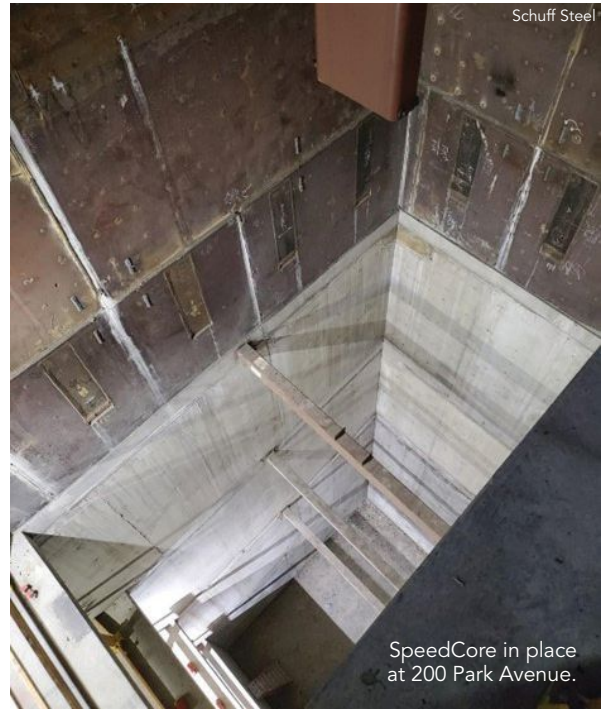

service tenants, and we wanted the health and well-being of the building occupants to be front and center.

At Gensler, we design buildings from the inside out, which means focusing on the building’s occupants first and foremost and analyzing how the architecture shapes that interior experience. The parcel the building sits on is almost a perfect square. When you extrude it upward, you essentially have a large cube with large floor plates.

When laying out the building core with the envelope location, this diagram resulted in a nearly 80-ft span from the perimeter to the core. Carvings around the perimeter created vertical canyons and avoided potential deep and dark floorplates. These “solar canyons” bring daylight deeper into the building and visually break down the scale of the mass from the exterior. The canyons were sculpted and located to correspond to specific interior programmatic spaces, including the entries and amenity areas. Bridges were inserted within the canyons to allow for exterior access for all tenant floors and to self-shade the building. This process was independent of SpeedCore.

What do SpeedCore’s long, clear spans between the core and exterior façade do from an architect’s perspective, and how does it influence the architecture?

The lease span (distance between the core walls and the façade) was at the forefront of our minds as we designed the building and heavily influenced the solar canyons.

In addition to the increased daylight and outdoor space, the solar canyons allow for appropriately scaled interior workplace ‘neighborhoods.’

In this way, the tenant floors don’t feel like huge trading floors where the space is vast. They have a dense open floor plan seating. It feels more well-scaled, even though the floor plates are large and can accommodate large numbers of employees. The

in-and-out façade configuration and the relationship of the windows to the core around the floor plate allow for different workplace experiences.

Was the collaboration between the engineer and the architects any different than usual because of SpeedCore?

It wasn’t vastly different. But as previously mentioned, the timing pushes coordination up in the project schedule. Our structural engineers bringing awareness to SpeedCore when it otherwise wasn’t at the top of the project team’s collective minds was helpful.

We worked closely with the project contractor and specified full-scale core mockups off-site so that the project team could see, touch, and understand the system because it’s new. Schuff Steel, the fabricator, created an 18.5-ft L-shaped mockup of the typical 4.5-ft splice height above working floors. We wanted to see the steel, pour concrete in the steel to verify adequate compaction of the concrete fill, and learn as many fabrication and installation lessons as possible before construction on site.

The compaction of the concrete, in particular, is hard to see because the SpeedCore formwork is essentially permanent. Those early mockups paid off because they ensured we proceeded with confidence.

Now that you’ve done it start to finish, what advantages did you discover with SpeedCore beyond timeliness and cost?

The idea that we could thin the walls was a big bonus. And as you amortize that over the height of the building, the extra space you create adds up. Knowing that there’s a possibility to expose the SpeedCore walls to have them be celebrated and seen is another bonus to be tested on future projects.

.....



left: Prefabricated SpeedCore pieces being erected.

below: Schuff used ½-in. ASTM A572 Grade 55 plate for most of the core wall elements.

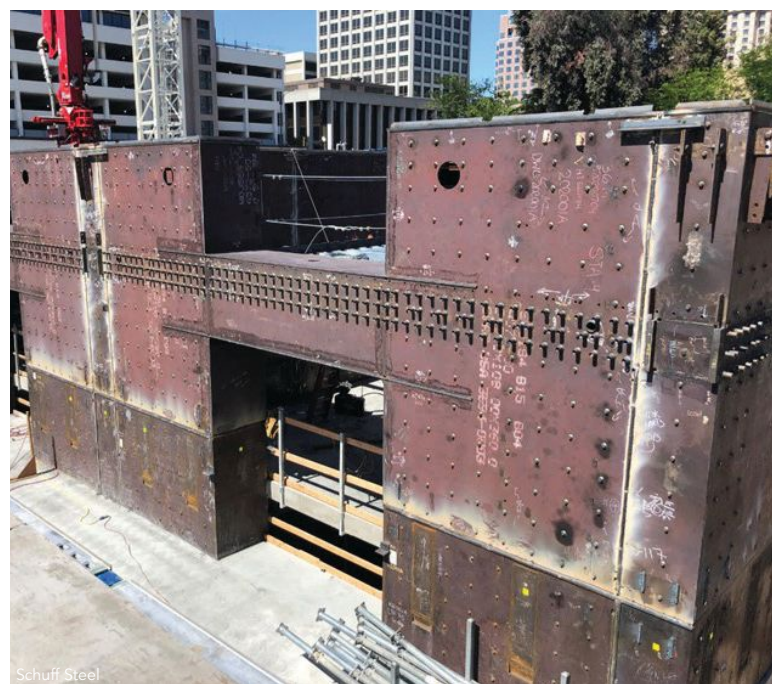



Outdoor terraces and bridges are a key feature of the building's design.

As far as the architecture of the building itself—and not necessarily related to SpeedCore—what are the most important building features, and what were you aiming for with its design and aesthetics?

From the outset, performance kept coming up in almost every design conversation. The building is fully electric. It's one of the first in the region and one of the first at this scale to be fully electric, meaning the building has the potential to be run on 100% renewable or green energy sources. As the power grid in California gets more green, the building can take advantage of that. It won't be locked into a traditional gas boiler system that conventional office buildings use as their main power source.

That's a big part of the building and helped lower the project's greenhouse gas emissions by about 73% from baseline.

We couple that with a high-performance façade and the canyons with the bridges to give you the indoor-outdoor feel. Nearly every design decision embodied this idea of redefining performance for the workplace experience: Create an energy-efficient exterior wall that limits air and water infiltration, maximizes views but still balances and controls direct solar gain, add all that outdoor space, and the daylight benefits the solar canyons add.

Do you think you'll see SpeedCore more often in your projects or be a bigger proponent of it when designing buildings?

It's something we want to consider, for sure. Every project has different constraints, exists within unique market conditions, and every owner has slightly different goals. But this project has proven that SpeedCore is more than worthy of consideration from designers when evaluating all the project-specific requirements and constraints. ■



Patrick Engel (engel@aisc.org) is the associate editor of *Modern Steel Construction*. **Chris Payne** (christopher_payne@gensler.com) is a Senior Associate at Gensler.

new products

This month's New Products section features a new cobot, a highly intelligent welding system, and wrenches for turn-of-nut installation.

Kane Robotics GRIT Cobot

Kane Robotics' GRIT™ is the first cobot solution innovated specifically to solve challenges in composites sanding and weld grinding. It works alongside humans to perform sanding, grinding, polishing, deburring and other labor-intensive material removal for any size manufacturer in a variety of industries.



The GRIT has helped composites manufacturers complete jobs such as:

- sanding primer from machine components
- removing coating and sanding surfaces for paint preparation or repairs on helicopter main rotor blades
- polishing fighter jet canopies after thermoforming to remove orange peel and achieve optical clarity
- deburring and weld grinding metal castings and other parts

Manufacturers in aerospace and other industries have seen impressive results from employing GRIT in their operations:

- Exponentially increased productivity: A 12-hour sanding job can turn into 3.5 hours when done by a GRIT cobot. Moreover, cobot sanding is precise and uniform, minimizing the need for further detail work before starting second-phase operations.
- Reduced health risks: Kane's GRIT cobot reduces repetitive injuries to wrists, elbows and shoulders as well as respiratory and ocular illness caused by airborne particles. In short, cobots help manufacturers keep their people—and keep them healthy.
- Filling job vacancies: U.S. manufacturers are having difficulty attracting new workers, especially for taxing work like sanding. GRIT cobots can help fill those roles, plus lessen the need to replace retiring workers as the manufacturing workforce ages.

To learn more, visit www.kanerobotics.com/grit-st.

ESAB Warrior Edge CX Welding System

ESAB's Warrior Edge 500 CX system allows new and experienced welders to achieve excellent welding results without a complex set-up process. It has built-in connectivity and comes with a subscription to the InduSuite WeldCloud Fleet online software application. RobustFeed Edge CX also features a new digital gas control technology called TrueFlow™ that improves welding quality, saves gas and helps avoid weld defects caused by improper flow rates.

The Warrior Edge 500 CX has a rated welding output of 500 amps at 60% duty cycle for synergic MIG/flux cored, pulsed MIG, Stick, gouging, and Live TIG. It features the company's next-generation digital control electronics for more controlled arc starts and greater arc stability to minimize spatter. It welds in the spray transfer, pulsed spray transfer and new



SPEED mode. The SPEED mode creates a more focused arc by taking a conventional spray transfer arc and overlaying a modified pulsed MIG wave form on top of it. Visit www.esab.com/us for more information.

GWY Turn-of-Nut Wrenches

GWY, LLC, offers an exclusive line of wrenches created for rotation-based method of installation, also known as the Turn-of-Nut method. We've combined our years of experience in bolt fastening with TONE's years of quality wrench manufacturing to custom design our Turn-of-Nut wrenches. Now available in two series, the TN and GPTN Turn-of-Nut wrenches meet the high state and federal standards for structural fastening that automatically tighten the bolt assembly to the preset rotation.

Upgraded from the original TN wrenches, the GPTN series is available in four models with an overall maximum torque of 3,700 ft-lb. and compatible with 3/4- to 1 1/2-in. diameter fully tensioned structural bolts. With an integrated reverse kit for counterclockwise torque control, a quick tap of the trigger easily releases the tool after each bolt installation. Additional features include overload protection, controllable angle range, and LED indicator lights. For more information, visit www.gwyinc.com.



KIMBROUGH AWARD

Michael Grubb to Receive AISC’s Highest Design Honor

AISC will present the J. Lloyd Kimbrough Award—which recognizes the pre-eminent steel designers of their era—to bridge industry legend Michael A. Grubb, PE, executive director at M.A. Grubb & Assoc., LLC.

Grubb is just the 13th person to receive the Kimbrough Award since 1941. Previous recipients include Ludwig Mies van der Rohe, Fazlur R. Khan, Leslie E. Robertson, John Kulicki, and, most recently, David I. Ruby.

“It’s hard to overstate Mike’s contribution to American infrastructure over his career,” said AISC President Charles J. Carter, SE, PE, PhD. “He’s been a relentless contributor, and nobody can communicate the big picture and the details behind it better. AISC is proud to recognize his accomplishments.”

Purdue University’s Robert J. Connor, Jack and Kay Hockema Professor of Civil Engineering and director of S-BRITE/CAI at the Lyles School of Civil Engineering, pointed to Grubb’s decades of work developing AASHTO LRFD BDS provisions for steel bridges.

“I am confident that Mike has had either a direct or indirect role in helping move every ballot related to steel bridges for AASHTO for at least 30 years,” Connor wrote. “His knowledge of the history of steel bridge design is unsurpassed. I would venture that he has instructed more engineers than most faculty have instructed in their entire careers, in terms of numbers of individuals in the classroom.”

Grubb has authored or co-authored 40 publications covering all aspects of steel girder bridge design—research work that consultant Karl H. Frank, PE, PhD, noted would satisfy tenure requirements at most universities.

“Mike’s publication record is extraordinary for a non-academic,” Frank noted in a nomination.



AISC SAFETY AWARDS

More Than 180 AISC Members Receive 2023 Awards

AISC is honoring more than 180 structural steel fabricators and erectors for their outstanding safety records in 2023. About 75% of this year’s 188 honorees earned the Safety Award of Honor, AISC’s top safety award.

“Avoiding accidents is not an accident,” said AISC Senior Director of Engineering Tom Schlafly. “Structural steel fabrication shops and construction sites are busy places with many activities occurring simultaneously. Skill, experience, and planning are required to accomplish those activities safely. AISC is proud of those companies whose employees worked through 2023 with few or no Days Away, Restricted or Transfer (DART) injuries.”

AISC relies on DART rates that companies report to OSHA to determine safety award recipients. The DART rate measures the number of recordable lost work cases per 200,000 hours worked. AISC bases the

awards on cases, not days, as reported to OSHA on the 300A form, along with the hours worked in the year.

AISC presents a Safety Award of Honor to fabricators and erectors with perfect records. Those with excellent records (0<DART≤1) earn a Safety Award of Merit, and Safety Commendations recognize companies with DARTs greater than one and less than or equal to two.

“I’m encouraged to see more companies make safety a priority at all levels of their company,” said, AISC Safety Committee Chair John Schuepbach, managing director for Phoenix Solutions Group International. “Prioritizing safety enhances productivity, bottom-line profits, employee-company relationships, reputation, and is a key factor in creating a sustainable workplace. We are pleased to see that many companies are aware of these broad benefits of prioritizing safety within their workplace and >>>

People & Companies

Stantec signed an agreement to acquire **Morrison Hershfield**, a 1,150-person engineering and management firm headquartered in Markham, Ontario. Founded in 1946, Morrison Hershfield has offices in 22 cities in Canada and the United States, and one office in India.

Walter P Moore promoted **Peter White** to Managing Director for the Diagnostics Group in the Charlotte office. White brings 20 years of experience in all aspects of diagnostics engineering, including parking restoration, enclosure diagnostics, restoration renovations, and forensics to his new role. The company also hired **Ashpica Chhabra** as Managing Director of the Structural Engineering team in its New York City office. Chhabra’s portfolio spans various sectors, including aviation, civic, federal, and tall buildings.

FORSE Consulting has promoted **Cathleen Jacinto** to Design Director and Partner. Jacinto joined the company in 2015 as a structural engineer. She is a member of the NASCC: The Steel Conference planning committee and a volunteer on AISC technical committees.

Severud Associates promoted **Fortunato Orlando** to Senior Associate Principal and **Steve Reichwein** to Associate Principal. Orlando joined the company in 1996 and has worked on several large-scale East Coast projects, including the 270 Park Avenue building that was featured in the January 2024 issue of *Modern Steel Construction*. Reichwein arrived in 2009 and is a leader of the firm’s parametric and algorithmic design team, which produces analyses that inform critical engineering decisions for major projects, including the Sphere in Las Vegas.

news & events

in the field. We appreciate the dedication these companies have shown in protecting their employees and keeping them healthy.”

The safety awards program is open to all AISC member fabricators and erectors, and applications for the program are solicited annually. Awards are issued separately for fabrication and erection companies. To win an award, the AISC member company must submit a copy of their OSHA 300A form for verification purposes.

For more information and resources on safety for the fabricated and erected structural steel industry, visit aisc.org/safety.



Safety Award of Honor (DART = 0) Fabricators

- 3 Sons’ Steel, Inc., Tarboro, N.C.
- AF Steel Fabricators, Chandler, Ariz.
- Affton Fabricating & Welding Co., Inc., Sauget, Ill.
- Arc Rite Welding & Fabrication, LLC, Pipe Creek, Texas
- Aristeo, Livonia, Mich.
- Arlington Structural Steel Company, Inc., Arlington Heights, Ill.
- Associated Steel Fabricators, Inc., Tomball, Texas
- B & B Welding Company, Inc., Sparrows Point, Md.
- Blue Atlantic Fabricators, LLC, East Boston, Mass.
- Bohling Steel, Inc., Lynchburg, Va.
- C.T. and S. Metalworks, Irving, Texas
- Chesapeake Bay Steel, Inc., Norfolk, Va.
- Continental Steel Works Inc., Butte, Mont.
- Cooper Steel South LLC, Childersburg, Ala.
- Corebrace, LLC, West Jordan, Utah
- Crowder Industrial Construction, Spartanburg, S.C.
- Delta Steel Inc., Saginaw, Mich.
- Design Build Structures, LLC, Peosta, Iowa
- Diversatech-Metalfab LLC, Gridley, Ill.
- Dixie Southern Industrial, Inc., Polk City, Fla.
- Doral Corporation, Milwaukee
- Douglas Steel Company, Lansing, Mich.
- Douglas Steel Fabricating Corporation, Lansing, Mich.

- East Coast Metal Structures, Corp., Riviera Beach, Fla.
- Edco, Inc., Mount Vernon, Wash.
- Eddy’s Welding, Inc., Ellicott City, Md.
- Forney Welding, Inc., Albuquerque, N.M.
- Garbe Iron Works, Inc., Aurora, Ill.
- Gibson Industrial Inc., Richmond, Va.
- GMF Steel Group, Lakeland, Fla.
- Hartland Building & Restoration Co., East Granby, Conn.
- Haskell Corporation, Bellingham, Wash.
- Hershberger Bros. Welding Inc., Las Vegas
- High Plains Steel Services, LLC, Windsor, Colo.
- Hubbard & Drake Inc., Decatur, Ala.
- Industrial Maintenance and Fabrication, Mead, Colo.
- Intermark Steel LLC, Price, Utah
- J.B. Steel, Tucson, Ariz.
- J.R. Hoe and Sons, Middlesboro, Ky.
- Jeffords Steel & Engineering Co., Potsdam, N.Y.
- JGM Fabricators & Constructors, LLC, Coatesville, Pa.
- Larwel Industries, Bedford, Texas
- Lee’s Imperial Welding Inc, Fremont, Calif.
- Levan Associates Inc., Emmaus, Pa.
- LMC Industrial Contractors, Avon, N.Y.
- Lyndon Steel Company, Winston-Salem, N.C.
- McCombs Steel Company, Inc., Statesville, N.C.
- Mechanical & Industrial Steel Services, Inc., Chicago
- Missouri Fabricators, Fulton, Mo.
- Mobil Steel International, Inc., Houston
- NOVA Group, Inc., Napa, Calif.
- Ogeechee Steel, Inc., Swainsboro, Ga.
- Phoenix Fabrication & Supply, Inc., Peotone, Ill.
- Precision Build, LLC, Gibsonton, Fla.
- Premier Fabrication, LLC, Congerville, Ill.
- Quality Welding and Fabrication, Elida, Ohio
- Reinicke Athens Inc., Athens, Ga.
- RBD Holdings LLC, Alexander, Ark.
- RNGD, LLC, Metairie, La.
- Rochester Structural, LLC, Rochester, N.Y.
- Rocky Mountain Steel, Inc., Olathe, Colo.

- San Joaquin Steel Co., Inc., Stockton, Calif.
- Sanpete Steel Corporation, Moroni, Utah
- SC Steel, LLC, Taylors, S.C.
- Schuff Steel Company, Stockton, Calif.
- Schuff Steel Company, Ottawa, Kan.
- Schuff Steel Company, Bellemont, Ariz.
- Shure Line Construction, Kenton, Del.
- Simko Industrial Fabricators, Chesterton, Ind.
- SME Steel Contractors, Inc., Pocatello, Idaho
- SME Steel Contractors, Inc., West Jordan, Utah
- Southwest Architectural Metals, Henderson, Nev.
- Standard Iron Works, Scranton, Pa.
- Steel Specialty, Inc., Belmont, N.C.
- Stud Welding, Inc., Centerville, Tenn.
- T.W.S. Fabricators, Inc., Fort Lauderdale, Fla.
- Talley Metal Products, Inc., Hagerstown, Md.
- The Gateway Company of Missouri LLC, St. Louis
- The Haskell Company, Jacksonville, Fla.
- Tipton Structural Fabrication, Tipton, Iowa
- Tipton Structural Fabrication, Cedar Rapids, Iowa
- TrueNorth Steel, Lubbock, Texas
- TrueNorth Steel, Mandan, N.D.
- Turner Construction Company, Huntsville, Ala.
- Twin Brothers Marine, LLC, Morgan City, La.
- United Structural Works, Inc., Congers, N.Y.
- Universal Steel of NC, LLC, Thomasville, N.C.
- USA Structural Steel & Foundations, Sarasota, Fla.
- Viking Steel Fabricators, Fredericksburg, Va.
- VM Ironworks & Structural Steel Corp., Palm City, Fla.



Safety Award of Honor (DART = 0) Erectors

- AF Steel Fabricators, Chandler, Ariz.
- American Steel Fabricators, LLC, Greenfield, N.H.



- B & B Welding Company, Inc., Sparrows Point, Md.
- Ben Hur Steel Worx, LLC, St. Louis
- Black Cat LLC, Cheyenne, Wyo.
- Bowen Engineering Corp., Indianapolis
- Cooper Steel, Nashville, Tenn.
- Douglas Steel Fabricating Corporation, Lansing, Mich.
- East Coast Metal Structures, Corp., Riviera Beach, Fla.
- Eddy's Welding, Inc., Ellicott City, Md.
- Gibson Industrial Inc., Richmond, Va.
- GMF Steel Group, Lakeland, Fla.
- Hartland Building & Restoration Co., East Granby, Conn.
- High Plains Steel Services, LLC, Windsor, Colo.
- Hubbard & Drake Inc., Decatur, Ala.
- Industrial Maintenance and Fabrication, Mead, Colo.
- J.B. Steel, Tucson, Ariz.
- JGM Fabricators & Constructors, LLC, Coatesville, Pa.
- March-Westin Company, Inc., Morgantown, W.V.
- Mechanical & Industrial Steel Services, Inc., Channahon, Ill.
- Meco Kentucky LLC, Louisville, Ky.
- Mid-Ohio Mechanical, Inc., Granville, Ohio
- NMI Industrial Holdings Inc., Sacramento, Calif.
- North Alabama Fabricating Company, Inc., Cullman, Ala.
- Peterson Beckner Industries, Inc., Houston
- Peterson Beckner Industries, Inc., Frisco, Texas
- Precision Build, LLC, Tampa, Fla.
- Reinicke Athens Inc., Athens, Ga.
- RBD Holdings LLC, Alexander, Ark.
- RNGD, LLC, Metairie, La.
- Rochester Structural, LLC, Rochester, N.Y.
- San Joaquin Steel Co., Inc., Stockton, Calif.
- Schuff Steel Company, Stockton, Calif.
- Schuff Steel Company, Lindon, Utah
- Schuff Steel Company, Portland, Ore.
- Schuff Steel Company, Bellevue, Wash.
- Shure Line Construction, Kenton, Del.
- Skanska Koch, Inc., Carteret, N.J.
- SME Steel Contractors, Inc., West Jordan, Utah
- Southwest Steel LLC Nevada, Henderson, Nev.
- Stinger Bridge & Iron, Coolidge, Ariz.

- Summit Industrial Construction, Houston
- United Structural Works, Inc., Congers, N.Y.
- United Weld Services, LLC, York, Pa.
- USA Structural Steel & Foundations, Sarasota, Fla.
- VM Ironworks & Structural Steel Corp., Palm City, Fla.



2023 SAFETY AWARD
★★

Safety Award of Merit ($0 < \text{DART} \leq 1$) Fabricator

- Custom Metals, a Division of Lexicon, Inc., Little Rock, Ark.
- DIS-TRAN Steel, LLC, Pineville, La.
- Environmental Air Systems, LLC, High Point, N.C.
- High Steel Structures LLC, Lancaster, Pa.
- Lexicon Industrial Contractors, a Division of Lexicon, Inc., Little Rock, Ark.
- MSD Building Corp., Pasadena, Texas
- PKM Steel Service, Inc., Salina, Kan.
- Prospect Steel, a Division of Lexicon, Inc., Little Rock, Ark.
- Prospect Steel, a Division of Lexicon, Inc., Armored, Ark.
- Schuff Steel Company, Humble, Texas
- Schuff Steel Company, Phoenix
- Schuff Steel Company, Lindon, Utah
- Schuff Steel Company, Eloy, Ariz.
- Steel Fabricators of Monroe, Monroe, La.
- Steel Service Corporation, Jackson, Miss.
- Steward Steel, Inc., Sikeston, Mo.
- Structural Steel & Plate Fabrication, Co., North Salt Lake, Utah
- Systems Fab & Machine, Inc., El Dorado, Ark.
- Team Industries Inc, Kaukauna, Wisc.
- TrueNorth Steel, Billings, Mont.
- W&W | AFCO STEEL, Lubbock, Texas



2023 SAFETY AWARD
★★

Safety Award of Merit ($0 < \text{DART} \leq 1$) Erector

- Aristeo, Livonia, Mich.
- Bosworth Steel Erectors, LLC, Dallas
- Building Zone Industries, Kanarrville, Utah

- Derr & Gruenewald Construction, LLC, Brighton, Colo.
- G.A. West & Co., Inc., Creola, Ala.
- Ideal Contracting, Detroit
- Kraemer North America, Plain, Wisc.
- Schuff Steel Company, Phoenix
- Schuff Steel Company, San Diego
- W&W | AFCO STEEL-W&W Steel Erectors, New York



2023 SAFETY AWARD
★

Safety Commendation ($1 < \text{DART} \leq 2$) Fabricator

- American Steel Fabricators, LLC, Greenfield, N.H.
- AFC Steel, LLC, Ennis, Texas
- Ben Hur Steel Worx, LLC, St. Louis
- Covenant Steel Warehouse, Inc., Dothan, Ala.
- Drake-Williams Steel Inc., Omaha, Neb.
- Environmental Air Systems, LLC, High Point, N.C.
- Gayle Manufacturing Company, Caldwell, Idaho
- Hillsdale Fabricators, a Division of Alberici Constructors, St. Louis
- New Industries, LLC, Morgan City, La.
- Patriot Erectors, LLC, Trinity North, Trinity, Texas
- Patriot Erectors, LLC, Trinity South, Trinity, Texas
- Precision Build, LLC, Tampa, Fla.
- Ramar Steel Sales, Inc., Rochester, N.Y.
- Sefton Steel, LP, Aldine, Texas
- Southwest Steel, LLC, El Mirage, Ariz.
- Stinger Bridge & Iron, Coolidge, Ariz.
- Thomas Steel, Inc., Bellevue, Ohio
- Thompson Metal Fab, Inc., Vancouver, Wash.
- Western Slope Iron & Supply, Inc., Grand Junction, Colo.
- Zimkor LLC, Littleton, Colo.



2023 SAFETY AWARD
★

Safety Commendation ($1 < \text{DART} \leq 2$) Erector

- Ben Hur Steel Worx, LLC, Indianapolis
- Ben Hur Steel Worx, LLC, Fairfield, Ohio
- Davis Erection, Gretna, Neb.

BJORHOVDE AWARD

Ahmad Hassan Earns Bjorhovde Outstanding Young Professional Award

The AISC Education Foundation has honored Degenkolb Engineers' Ahmad Hassan with the second-ever Reidar Bjorhovde Outstanding Young Professional Award.

Hassan graduated from the University of California, Davis with his PhD in structural engineering in December 2022. Shortly after, he began working at Degenkolb Engineers.

Hassan will kick off his upcoming year of steel industry exposure in March at NASCC: The Steel Conference, where he will receive recognition and connect with industry leaders and peers. Later this year, Hassan will visit a structural steel mill and fabrication shop to get an up-close look at the process before joining AISC at its November Task Committee meetings in Chicago.

"Ahmad has taken an active interest in AISC's activities, particularly in the development of our codes and standards," AISC Director of Foundation Programs Maria

Mnookin said. "We look forward to continuing Reidar Bjorhovde's legacy of mentorship through this program and engaging with individuals like Ahmad, who show great potential to be tomorrow's leaders."

The annual Reidar Bjorhovde Award honors young professionals who mirror the outstanding leadership and initiative of its namesake. The late Reidar Bjorhovde had a lifelong passion for mentorship and took many of today's brightest industry minds under his wing.

Amit Kanvinde, a structural engineering professor at UC Davis, the 2022 T.R. Higgins Award winner, and a notable contributor to AISC standards and research, recommended Hassan for the Bjorhovde Award.

"I have been extremely impressed with Ahmad's intelligence, work ethic, dedication, and professionalism," Kanvinde said. "He is one of the best students I have had the pleasure to supervise."



NAE

Structural Welding Expert Duane Miller Elected to National Academy of Engineering

Duane Miller, the leading authority on structural welding and a previous recipient of the AISC Robert P. Stupp Award for Leadership Excellence, has added another honor to his already lengthy list: membership in the National Academy of Engineering (NAE).



Miller was elected on February 6 in recognition of his contributions to engineering "for design, fabrication, and performance of welded structural steel connections and for contributions to welding education." He will be inducted during a ceremony at the NAE Annual Meeting September 29 to 30, 2024.

A mentee of the legendary Omer Blodgett, Miller worked at Lincoln Electric for 44 years before his retirement in 2022, serving much of his tenure as the company's manager of engineering services and welding design consulting. He is widely recognized as the leading expert on the design and performance of welded connections and has given lectures worldwide.

Miller has earned several AISC awards and is one of only ten people to receive a Stupp Award. AISC also honored Miller with the T. R. Higgins Lectureship Award in 2001 and a Lifetime Achievement Award in 2005. He is the only person to receive the Higgins, Lifetime Achievement, and Stupp awards.

In 2018, Miller became the first recipient of the AISC Steel Conference Speaker Award. He has authored or co-authored texts and chapters of many handbooks, including AISC Design Guide 21: *Welded Connections—A Primer for Engineers*, 2nd Edition and Chapter 15 of the *Highway Structures Design Handbook: Welding of Steel Bridges*.

Miller has served on many committees and currently sits on the AISC Committee on Specifications. He was chair of the American Welding Society (AWS) D1 Structural Welding Code Committee, was the first chair of the Seismic Welding Subcommittee, and was a co-chair of the AASHTO-AWS D1.5 Bridge Welding Code Committee.

Miller earned a bachelor's degree in welding engineering from LeTourneau University in Longview, Texas, and a master's in materials engineering from the University of Wisconsin-Milwaukee.



SMITH-EMERY

Inspection • Testing • Metallurgy

Assuring Structure & Life Safety Since 1904

Non-Destructive Testing

- PAUT
- Visual (CWI, CWB, CSWIP)
- MT
- UT

Owner QA

- Fabrication Oversight
- Specification Review
- Field Inspections
- WPS Reviews

Metallurgical Laboratory
Environmental Laboratory
Firestop Inspection

Supplier Audits

- IAS
- IAPMO
- City of Los Angeles
- Clark County, NV

Contractor QC

- Fabrication Shop NDT, CWI
- Vendor Audits
- QMS Development
- WPS and PQR Testing

Curtain Wall Performance Testing
Concrete Testing
Chemical Laboratory

1.833.405.0536

steel@smithemery.com

www.smithemery.com



Structural Engineers

Are you looking for a new and exciting opportunity?

We are a niche recruiter that specializes in matching great structural engineers with unique opportunities that will help you utilize your talents and achieve your goals.

- We are structural engineers by background and enjoy helping other structural engineers find their "Dream Jobs."
- We have over 30 years of experience working with structural engineers.
- We will save you time in your job search and provide additional information and help during the process of finding a new job.
- For Current Openings: visit our website, select Hot Jobs.
- Please call or email Brian Quinn, PE: 616.546.9420

Brian.Quinn@FindYourEngineer.com

so we can learn more about your goals and interests.

All inquiries are kept confidential.

SE Impact by SE Solutions, LLC | www.FindYourEngineer.com

marketplace & employment

Structural Engineering Software That Gives You Advantages

Real3D: A comprehensive structural analysis and design package featuring a quad-precision FEM solver, an intuitive interface, and the latest design code implementations.

sCheck: A steel section investigation and design tool featuring the latest AISC 360-22 Code and incredible Word/PDF reports for step-by-step calculations.

QuadMaker: A finite element mesh generator that produces 100% quadrilateral elements.

Customize Your Solution:

SolverBlaze –
Finite Element Solver

QuadSdk –
FEM Mesh Generator

Accurate. Fast. Beautiful.

Computations & Graphics, Inc.

www.cg-inc.com | info@cg-inc.com | Phone: 303.668.1091



LATE MODEL STRUCTURAL STEEL MACHINES AVAILABLE IMMEDIATELY

PEDDINGHAUS OCEAN AVENGER PLUS 1250/1C, 8-ATC, 3000 RPM, 40' Table, Siemens 840D, 2019, #32543

PEDDINGHAUS HSFDB 2500/B Plate Processor, HPR260XD Plasma, Drill & Oxy, 2014, #42977

PEDDINGHAUS PCD1100/3B, 40" Beam Drill, Siemens CNC, In & Out Feed Conveyor, 2016, #43033

PEDDINGHAUS (MEBA) 1250-510 Straight Cut, 49" x 20" Capacity, 20 HP, Re-Manufactured By Peddinghaus 2015, #32852

PEDDINGHAUS AFPS 643Q 6" x 6" x 5/8" Anglemaster, 230 Ton Single Cut Shear, Conveyor, 2011, #42975

PEDDINGHAUS PEDIWRITER PW-1250, (2) Hypertherm ArcWriter Torches, Siemens CNC, 2015, #32576

PYTHONX Robotic Plasma Cutting System, HPR260XD Plasma, Conveyor & Transfers, 2014, #32963

CONTROLLED AUTOMATION DRL-348TC Drill, 3-Spindle, ATC, Hem Saw, Conveyor & Transfers, 2009, #32361



SCAN QR CODE TO VIEW OUR LATEST INVENTORY

CALL US REGARDING YOUR SURPLUS EQUIPMENT, INDIVIDUAL ITEMS OR COMPLETE PLANTS

Contact: Claire@PrestigeEquipment.com

www.PrestigeEquipment.com | (631) 249-5566

To advertise, contact Geoff Weisenberger: 312.493.7694 | weisenberger@aisc.org. Search employment ads online at www.modernsteel.com.

advertiser index

Automated Layout Technology	45	Machitech/Beamcut	21
Birmingham Fastener	3	Nucor	68
Chicago Metal Rolled Products	insert	Peddinghaus	2
Combilift	12	QuickFrames	43
Controlled Automation	18	SDS2/Allplan	7
Integrated Engineering Software	11	St. Louis Screw and Bolt	21
JLG Industries	5	Voortman	10

structurally sound ...



Buffalo Bills

Buffalo's Big Build

NEW HIGHMARK STADIUM, the future home of the Buffalo Bills, reached a high mark in February with the setting of its first structural beam.

Following seven months of site excavation, the 40-ft-long, 13-ton beam marked the start of steel erection, which is expected to take 12 to 14 months and involves five cranes. Construction crews set the beam after a ceremony where project team members, workers, Bills staff, New York state officials, and Gov. Kathy Hochul signed a

smaller beam that will be erected later in the project.

AISC member fabricator Cives Steel Co. is fabricating all 25,000 tons of steel for the project at three of its New York shops. About 60 percent of the steel will be produced in New York, state officials said.

“Collectively, more than 800 people have worked 138,000 hours to achieve this important project milestone,” said Joe Byrne, program director for general contractor Gilbane-Turner. “Their neighbors

and friends in the community will now visibly be able to see the stadium take shape over the course of the next two years.”

One of Western New York's largest-ever construction projects, the 1.35 million-sq.-ft open-air stadium will seat approximately 60,000 fans. It's located in Buffalo suburb Orchard Park, directly across from the Bills' existing home (also called Highmark Stadium), and is expected to open shortly before the 2026 football season. ■

NASCC: THE STEEL CONFERENCE

aisc.org/nascc

THANK YOU TO OUR SPONSORS!

PLATINUM

Nucor

GOLD

Atlas Tube,
A Zekelman Company
Autodesk
CADeploy
SDS2 by ALLPLAN
Controlled
Automation
ideCAD
Moldtek

SAFETYCON

IMPACT/Iron Workers
Investment Recovery Services
SME Industries
Baden Steel
Big B Crane
Deem Structural Services
Steel Erectors Association
of America (SEAA)
Steel Service
Able Steel
Merrill Steel

SILVER

JMT Consultants, Inc. | Procore | IMPACT/Iron Workers
Canam Group | Canam Steel Corporation
Greenbrook Engineering Services | High Steel
IDEA StatiCa | Investment Recovery Services
IRyS Global | New Millennium | Peddinghaus
Sherwin-Williams Protective and Marine
SME Industries | Stupp Bridge Company
W&W | AFCO Steel

BRONZE

Taylor Devices | Larson Engineering, Inc.
National Council of Structural Engineers Associations
(NCSEA) | Steel Dynamics, Inc.
Baden Steel | Big B Crane | Deem Structural Services
Steel Erectors Association of America (SEAA)
Steel Service | Applied Bolting | Bull Moose Tube
Chicago Metal Rolled Products | Diligent | Gerdau
Hercules Bolt Company | Hi-Q Design | Infra-Metals
Team Detailing Solutions | Terracon Consultants

ELEVATE

Procore | IMPACT/Iron Workers | W&W | AFCO Steel
Taylor Devices | Larson Engineering, Inc.
National Council of Structural Engineers Associations (NCSEA)
Steel Dynamics, Inc. | A.C.T. Metal Deck Supply
Degenkolb Engineers and Ruby + Associates,
a Degenkolb Company | Steel Plus Network
AL Tech Global, LLP | Bendco | Cast Connex | Cohen Seglias
Exact Detailing | GWY | Harley Ellis Devereaux | Linq
SE U by SE Solutions | Spencer Freight and Logistics
TÜV Rheinland | Wiss, Janney, Elstner Associates, Inc.

NSBA RECEPTION

High Steel | Stupp Bridge Company | Casco Bay | Danny's Construction | Veritas Steel



AEOS™
ASTM A913

HIGH-STRENGTH
STRUCTURAL STEEL

REIMAGINE ...

EFFICIENCY

MATERIAL STRENGTH

DESIGN

SUSTAINABILITY



Design with Aeos™ high-strength ASTM A913 structural steel. A high strength-to-weight ratio means fewer tons and a lower carbon footprint for your project. Aeos is also the lowest embodied carbon steel of its kind, made with more than 95% recycled content using a circular steelmaking process with electric arc furnace (EAF) technology.



DISCOVER THE AEOS™ ADVANTAGE

nucor.com/aeos

NUCOR®